

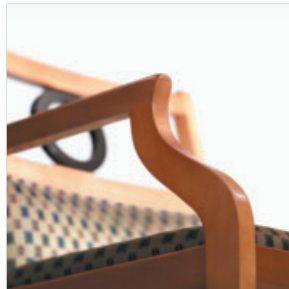

Price List 194
September 1, 2007

DELIVERED LIST PRICING



Guest

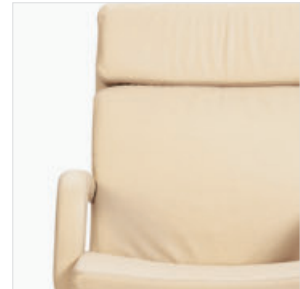

Desk & Conference

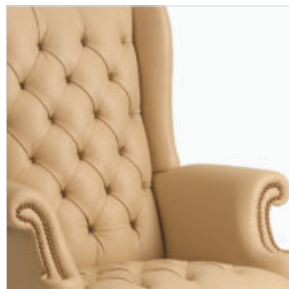

Traditional

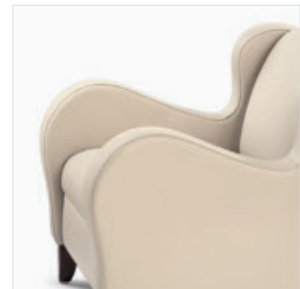

Lounge & Multiple

TABLE OF CONTENTS

Numerical Index	2-3
General Information	4-9
Bases	10
Taylor Fast Ship	11
Guest Seating	12-23
Zoe	12
Crawford.....	13-14
Classic.....	15-16
Triax.....	16
Moselle.....	17
City.....	18-19
Bella.....	20-21
Crescent.....	21-23
Desk & Conference	24-37
Zoe	24-25
Parker.....	25-27
Classic.....	28
Bentley	28-30
Aurora.....	30-33
Ventura.....	33-37
Traditional	38-61
Chippendale.....	38-46
Hepplewhite	43
Traditional Executive.....	46-49
English Hepplewhite.....	49-52
Courthouse	53
Captain.....	53
Chippendale Lounge.....	53-55
Judge	55
Arlington.....	56-61
Lounge & Multiple	62-90
Lexi.....	62
Lydia.....	62-63
Hampton.....	63-70
Elwood	71-74
Cosmo.....	75-76
Maxwell	75, 77
Metro.....	75, 78
Savannah	75, 79
Shelby	75, 80
Zoe Multiple Seating & Tables.....	81-84
Orbit Lounge System & Tables	85-90
Occasional Tables (Bedford Collection & Paull Group)	91-93
Upholstery Requirements & Weights	94-95

NUMERICAL INDEX

2110.5	24	2554T	67	2812.5T	48
2111	12, 82	2555.....	67	2812.5TLC.....	48
2111-2S.....	82	2556.....	68	2813.5.....	48
2111-3S.....	82	2556W	68	2813.5T	49
2112.....	12, 83	2574.....	68	2813.5TLC.....	49
2112-2S.....	83	2574C.....	69	2814	49
2112-3S.....	83	2574W	69	2814T	50
2113.....	12	2574T	69	2814-4	50
2115.5	24	2575.....	70	2814T-4.....	50
2120.5	24	2576.....	70	2814.5.....	51
2125.5	25	2576W	70	2814.5T	51
2227-L	86	2804-WLT	38	2816.....	51
2227-M	86	2806	38	2816T	52
2227-R.....	86	2806T	38	2816.5.....	52
2230-L	87	2806-4	39	2816.5T	52
2230-M	87	2806T-4.....	39	2818.....	53
2230-R.....	87	2806UA.....	39	2819.....	53
2329.....	62	2806TUA.....	40	2831.....	53
2359.....	62	2806UA-4.....	40	2831T	54
2429.....	62	2806TUA-4	40	2860.....	54
2459.....	63	2806CA.....	41	2860T	54
2510.5	25	2806TCA	41	2880.....	55
2510.5BA	25	2806CA-4	41	2880T	55
2510.5CA.....	26	2806TCA-4	42	4800.5.....	55
2511.5.....	26	2806.5UA.....	42	7414.....	13
2520.....	63	2806.5TUA.....	42	7415.....	13
2520.5	26	2806.5CA.....	43	7415PA	13
2520.5BA	27	2806.5TCA	43	7416.....	14
2520.5CA.....	27	2807.5	43	7417.....	14
2521.5.....	27	2808	44	7417PA	14
2530	63	2808T	44	7612	15
2530C.....	64	2808CA.....	44	7612.5.....	28
2530W	64	2808TCA	45	7613	15
2530T	64	2808.5	45	7614	15
2531.....	65	2808.5T	45	8114	16
2532.....	65	2808.5CA.....	46	8114.5.....	28
2532W	65	2808.5TCA	46	8810.5BA	28
2550.....	66	2811.5.....	46	8810.5UA	29
2554.....	66	2811.5T	47	8810.5CA	29
2554C.....	66	2811.5TLC.....	47	8811.5BA	29
2554W	67	2812.5.....	47	8811.5UA	30

NUMERICAL INDEX

8811.5CA	30	9713-XB	20	9920MET	75
9015.....	16	9714.....	21	9930MET	78
9015-N.....	16	9715.....	21	9954MET	78
9316.....	17	9720.5CL.....	35	9974MET	78
9317.....	17	9720.5CL-BA	36	9920SAV	75
9318.....	17	9720.5PF	36	9930SAV	79
9336.....	71	9720.5PF-BA.....	36	9954SAV	79
9336FP	71	9720.5SC.....	37	9974SAV	79
9337.....	71	9720.5SC-BA	37	9920SLB.....	75
9337FP	72	9810.5RA	56	9930SLB.....	80
9360.....	72	9810.5UA.....	56	9954SLB.....	80
9360FP	72	9810.5CA	56	9974SLB.....	80
9361.....	73	9815.5RA	57	BC2030	91
9361FP	73	9815.5UA.....	57	BC2042	91
9384.....	73	9815.5CA	57	BC2424	91
9384FP	74	9820.5RA	58	BC3030	91
9385.....	74	9820.5UA.....	58	BC3030-16	91
9385FP	74	9820.5CA	58	CV-CT.....	84
9411.....	18	9825.5RA	59	CV-MT.....	84
9412.....	18	9825.5UA.....	59	OTT-R	88
9414.....	18	9825.5CA	59	OTT-T	88
9415.....	19	9830.5RA	60	PG2030	92
9416.....	19	9830.5UA.....	60	PG2042	93
9417.....	19	9830.5CA	60	PG2424	92
9500.5.....	30	9835.5RA	61	PG24R.....	92
9500.5BA	31	9835.5UA.....	61	PG24RD	92
9500.5CA	31	9835.5CA	61	PG3030	93
9510.5.....	31	9911.....	21	PG3030-16	93
9510.5BA	32	9912.....	22	SAT-120D.....	89
9510.5CA	32	9912PA	22	SAT-3W	88
9520.5.....	32	9913.....	22	SAT-EN	89
9520.5BA	33	9913PA	23	SAT-INL.....	89
9520.5CA	33	9920COS.....	75	SQ-CT	84
9710.5CL.....	33	9930COS.....	76	SQ-ET.....	84
9710.5CL-BA	34	9954COS.....	76	SQ-MT	84
9710.5PF	34	9974COS.....	76	ST15R	90
9710.5PF-BA.....	34	9920MAX.....	75	ST15T.....	90
9710.5SC.....	35	9930MAX.....	77	T30R.....	90
9710.5SC-BA	35	9931MAX.....	77	T30T	90
9711-XB	20	9954MAX.....	77		
9712-XB	20	9974MAX.....	77		

5 | 15 **BOLD items are fast ship (see page 11 for more information).**

GENERAL INFORMATION

Order Information

Mail or fax all orders or inquires to:

The Taylor Chair Company
One Taylor Parkway
Bedford, Ohio 44146
Phone: 440-232-0700
Fax: 440-439-6720
E-Mail: info@thetaylorcompanies.com

All orders are subject to acceptance by The Taylor Chair Company.

Phone and E-Mail Orders

Taylor Chair accepts phone and e-mail orders; however, a mailed or faxed purchase order marked "confirming" must follow immediately. Duplication of an order not marked "confirming" is the responsibility of the customer.

GSA Contract

Most Taylor seating is on GSA Contract (#GS-28F-0047J). Please contact Customer Service or visit our website (www.thetaylorcompanies.com) for more details.

Special Orders

A minimum deposit of 50% of the quoted price is required on all orders for special construction, custom upholstery application, or jury bases. Special orders are not cancelable and Taylor Chair will not accept return of such orders. Lead time for special orders will be quoted at the time the order is received.

Terms and Credit Policy

Terms are 2% 10 days, net 30 days. Merchandise is shipped F.O.B. Bedford, OH, freight prepaid and allowed. Title passes to the purchaser upon receipt by the transportation company. Prices are subject to change without notice and all orders are accepted subject to prices prevailing at time of shipment. Distribution of this price list does not constitute an offer to sell. New customers are required to complete and return a credit application. **New customers are required to make a minimum deposit of at least 50% on their first order, unless other arrangements have been made.**

Past due accounts of 10 days or more are subject to being placed on credit hold until satisfactory arrangements are made. Any account that has an unpaid invoice that is 30 days past due will be placed for collection. Notification will be sent at such time. The customer will be responsible for all collection costs in the event their account must be placed for collection.

10 Year Limited Warranty

The Taylor Chair Company (Taylor) warrants to the first purchaser for use that its merchandise (including mechanisms, controls and gas cylinders, but excluding embroidery, embossing, upholstery cover, foam, and padding materials) is free of defects in material and workmanship for a period of ten (10) years from date of invoice, provided that such merchandise is listed in Taylor's current price list at the time of the claim and that such defects are not the result of ordinary wear and tear. Taylor's obligation under this warranty is limited to repair or replacement, at its option, and such repair or replacement shall be the only remedy. Because wood is a natural product, variations in grain and finish color may occur. Therefore, Taylor cannot guarantee the matching of grain or color. Taylor is not responsible for damage due to transportation, improper handling, alteration, abuse, or negligence. Taylor shall not be liable for any incidental or consequential damages including, but not limited to, any expenses associated with the removal or installation of any defective merchandise covered by this warranty. Taylor makes no implied warranty of merchantability or fitness for any particular purpose. **ALL OTHER WARRANTIES, EXPRESSED OR IMPLIED, ARE EXCLUDED.**

Designs

Designs in our catalog and price list are the property of Taylor Chair. Taylor Chair reserves the exclusive right to produce and market them. Some of the designs in our catalog and price list have design patents pending. Anyone duplicating them or planning to have them reproduced will be liable for patent infringement. Taylor Chair retains the right to change, at any time, materials or construction methods which, in our opinion, will improve our product. **All measurements and weights in the catalog and price list are approximate.**

Acknowledgements

Every order is acknowledged. An order will be manufactured and invoiced based upon information in the acknowledgement. If there is any discrepancy between the original order and acknowledgement, please notify the Customer Service Department immediately.

Changes and Cancellations

Orders are not subject to change or cancellation once frame production has begun or after the upholstery cover has been cut. Order revisions may be subject to schedule and price adjustments.

Cartons

All prices include cartoning and are packaged one item to a carton. All cartons and packing materials meet the requirements of the uniform freight classifications.

Freight Claims and Damaged Shipments

We take great care in the handling of our finished product. All Taylor Chair products are carefully inspected, protected with well-engineered packaging, and expertly loaded from our dock. All shipments are delivered to the transportation company in good condition and our liability ceases at that time. Therefore, **we strongly recommend that all furniture be inspected immediately upon arrival.** Do not refuse merchandise damaged in transit, as Taylor is not responsible for damage to goods that occur in transit or storage. **If a shipment is received damaged, whether such damage is concealed or obvious, it is the purchaser's responsibility to note the damage on the shipping receipt and contact the carrier immediately in order to file a freight claim. A delay in contacting the carrier may jeopardize your right to file a claim.** If a shipment is delivered short, please note the shortage on the shipping receipt.

The delivering carrier may not accept responsibility for damages if signed for "clear". **Notification of concealed damage claims must be made to the delivering transportation company within 5 days after delivery. All cartons must be available for inspection.** Transportation company liability ceases after 5 days and neither Taylor, nor the transportation company, will be responsible for concealed damages.

Taylor's warranty is null and void if product is stored or installed in an environment where temperature and humidity are not controlled, 24|7|365.

Returns

No furniture may be returned for credit, inspection, or repair without first obtaining factory approval and a return authorization number. In the event of a credit by agreement, a handling charge of at least 30% will be deducted from the credit issued. **No furniture will be accepted unless a return authorization number is referenced and return transportation charges are prepaid. All furniture being returned must be properly packaged in its original or comparable replacement packaging to ensure protection of the product during handling and transportation.**

GENERAL INFORMATION | SHIPPING

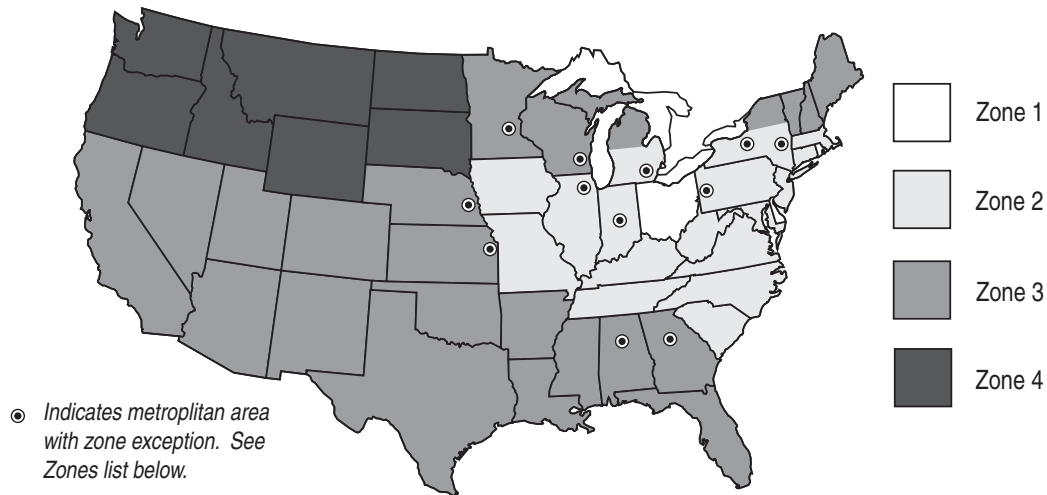

Delivery and Freight Charges

Zone list pricing includes freight prepaid by Taylor for delivery to one destination only within the zone. Inside delivery, unloading, and installation are not included in the list pricing and are the sole responsibility of the purchaser. Alaska and Hawaii are not included within the zone pricing and must be priced F.O.B. Bedford, OH before freight charges. Please contact Customer Service for freight charges to Alaska or Hawaii.

Routing

Taylor reserves the right to select the most appropriate carrier and/or routing on all shipments. If the purchaser specifies a carrier, other than a pre-approved carrier, freight will ship collect at the purchaser's expense via that carrier.

Miscellaneous Freight Charges

A \$30 (net) charge will be added to orders that request a call before delivery. Charges for special requests, including but not limited to, non-dock deliveries and residential deliveries, will be added to the purchaser's invoice.

Occasional Table Freight Charges

For occasional tables that ship via UPS, add the following surcharges to the list price per table:

Zone 1 & 2:	+\$75 list per table
Zone 3 & 4:	+\$125 list per table

Minimum Prepaid Freight Charges

Minimum prepaid freight charges will apply to the following seating orders in all zones:

4 or less guest chairs	+\$95 list per order
5 or less chairs in any combination of guest, swivel, lounge, etc.	+\$195 list per order

Large Order Discount

For large seating orders of 20 units or more (any combination of guest, swivel, lounge, etc.), please contact Customer Service for pricing at 1-888-758-2956 or info@thetaylorcompanies.com.

Zones

Zone list pricing is determined by the destination state or greater metropolitan area listed below:

Zone 1	Zone 2	Zone 3	Zone 4
Ohio	Connecticut	Alabama	Idaho
Chicago, IL	Delaware	Arizona	Montana
Detroit, MI	District of Columbia	Arkansas	North Dakota
Indianapolis, IN	Illinois	California	Oregon
Pittsburgh, PA	Indiana	Colorado	South Dakota
	Iowa	Florida	Washington
	Kentucky	Georgia	Wyoming
	Maryland	Kansas	
	Massachusetts	Louisiana	
	Michigan, South	Maine	
	Missouri	Michigan, North	
	New Jersey	Minnesota	
	New York, South	Mississippi	
	North Carolina	Nebraska	
	Pennsylvania	Nevada	
	Rhode Island	New Hampshire	
	South Carolina	New Mexico	
	Tennessee	New York, North	
	Virginia	Oklahoma	
	West Virginia	Texas	
	Albany, NY	Utah	
	Atlanta, GA	Vermont	
	Birmingham, AL	Wisconsin	
	Kansas City, MO		
	Milwaukee, WI		
	Minneapolis, MN		
	Omaha, NE		
	Syracuse, NY		

GENERAL INFORMATION | UPHOLSTERY & LEATHER

Upholstery Covers

Although we attempt to select fabrics for their quality, as well as performance, WE CAN NOT GUARANTEE ANY UPHOLSTERY COVER with regard to wearability, color fastness, or shrinkage beyond that which the fabric manufacturer extends to Taylor. Because of industry dye lot variations, colors may not match exactly. Zippers and cushions do not indicate that covers can be removed for cleaning.

Fabric Puddling

The content of certain fabrics makes these fabrics susceptible to puddling and wrinkling over which Taylor has no control. Slight changes in weather and humidity can affect these fabrics. Taylor will not assume responsibility in such cases.

Dimensions

All dimensions in our catalog and price list are approximate. Varying thickness of coverings and the individual upholstery technique of each craftsman account for small variations in the dimensions. We assume no responsibility for overall width, depth, or height unless items are special ordered to fit within an exact space.

Customer's Own Material (COM)

Yardage requirements for cover materials are listed in this price list and are based on plain fabrics 54" wide. If the fabric has a large repeat, stripe, or pattern, please send a sample and Customer Service will advise the additional material required. If these fabrics require special handling, Customer Service will advise you of the extra upholstery charge which will not exceed 15% of the COM price of the chair. The chart below illustrates the additional material required for fabrics with larger repeats:

Fabric Width	Plain Fabric	2"-14" Repeat	15"-19" Repeat	20"-27" Repeat	28"-36" Repeat
54	0%	10%	15%	20%	25%
50	10%	20%	25%	30%	35%
48	15%	25%	30%	35%	40%
45	40%	50%	55%	60%	65%
36	50%	60%	65%	70%	75%

Customer's own leather requirements are listed in the price list and are based upon usable square footage of leather. **On COM with stripes or patterns, specify direction as to horizontal or vertical. Unless otherwise specified, the fabric will be cut at our discretion.** We do not recommend striped or directional fabrics on barrel-shaped or tufted chairs. Depending on the fabric, it may not always be possible to run the horizontal or vertical without seams.

Ship your COM/COL prepaid to:

The Taylor Chair Company
One Taylor Parkway
Bedford, Ohio 44146

Mark packages with:

- Your name and order number
- Model # of upholstered pieces upon which cover is to be applied

Knoll Textiles, Maharam, and Momentum Textiles

Taylor Chair has alliances with Knoll Textiles, Maharam, and Momentum. Through these alliances, most Knoll Textiles, Maharam, and Momentum fabrics are standard on all Taylor seating. Knoll Textiles, Maharam, and Momentum fabrics are graded directly in the price list for each seating model; therefore, **it is not necessary to order these fabrics as a COM.** As a result, only one purchase order is needed, which eliminates the time and expense typically involved with a COM order.

To use each program, simply identify the pattern name and corresponding price grade from the respective Taylor Fabric Grade reference card in your Taylor binder. Then, locate the Taylor model number in the price list to determine the final seating price. Orders should be marked with the pattern number, pattern name, and color number. **Do not write "COM" on the order.** The price of Taylor seating upholstered with Knoll Textiles, Maharam, and Momentum fabrics is calculated according to grade and includes the cost of upholstery material. The repeat is also accounted for and no additional upcharge is needed. **Memo Samples are available directly through each company:**

Knoll Textiles: 1-800-343-5665

Maharam: 1-800-645-3943

Momentum Textiles: 1-800-366-6839

NOTE: For Knoll Textiles, Maharam, and Momentum fabric patterns not graded-in, please contact Customer Service for pricing.

Leathers

The contemporary leathers used by Taylor have been carefully selected to meet the highest standards for uniform color, softness, and wear. The natural nuances of leather have unique and individual characteristics; therefore, no two hides are identical. Since cattle are susceptible to the rigors of outdoor living, the beauty is defined by natural imperfections. These imperfections include growth marks, scars, grain, and shade variations that are unique features to each hide and are not considered a defect. We make every attempt in our cuttings to ensure that the most visible areas are clean and to use these natural features in the obscure areas of our product.

Dakota Leather (Grade L1)

This top grain leather is lightly sanded to minimize imperfections. Feel agents are added to moisten and soften during the extensive milling process.

Net Price:	1-10 hides	\$8.95 per sq. ft.
	11-20 hides	\$8.50 per sq. ft.
	21+ hides	\$7.95 per sq. ft.

Source of Leather:	Germany
Tannage:	Chrome Tanning
Grain:	Top Grain
Dyeing:	Aniline Dyed
Finish:	Heavy, breathable, protective
Weight:	2.25 - 2.5 oz. per square foot
Thickness:	0.9 - 1.0 mm
Size:	50 - 55 square feet per hide

GENERAL INFORMATION | UPHOLSTERY & LEATHER

Dakota Leather (Grade L1) - continued

Performance Characteristics:

Abrasion Resistance:	ASTM D-3884 (CS10 wheels) 750+ cycles
Color Fastness:	72 hour exposure
Dry Crocking:	Class 4-5
Wet Crocking:	Class 4
Flammability:	Cal. Tech Bulletin 117; Boston Fire Dept. BFD IX-1; Cigarette Ignition Resistance (NFPA-260) - Class I; Surface Burning Characteristics of Bldg. Materials (ASTM E84) Class II (Class I with flame treatment); IMO Resolution A.652

NOTE: Has been successfully used in CAL 133 applications with Fireguard F187 fire backer material.

Taylor Leather (Grade L2)

This top grain, semi-aniline dyed leather employs a slight hint of surface pigmentation to enhance its color consistency for a variety of applications.

Net Price:	1-10 hides	\$9.95 per sq. ft.
	11-20 hides	\$9.50 per sq. ft.
	21+ hides	\$8.95 per sq. ft.
	Custom Color	\$10.50 per sq. ft.

Source of Leather:	United States
Tannage:	Chrome Tanning
Grain:	Top Grain Full Grain (TL707 Black only)
Dyeing:	Aniline Dyed
Finish:	Semi-Aniline, Embossed (solvent free)
Weight:	2.5 - 2.75 oz. per square foot
Thickness:	1.0 - 1.2 mm
Size:	55 square feet per hide

Performance Characteristics:

Abrasion Resistance:	CS10 Wheel Taber Test 100 cycles/500 gram weight
Color Fastness:	72 hour exposure
Dry Crocking:	AATCC 8,500 cycles
Wet Crocking:	AATCC 8,800 cycles

Flammability:	Cal. Tech Bulletin 117; Boston Fire Dept. BFD IX-1; NY/NJ Port Authority
---------------	--

Spinneybeck Leather

The Taylor Chair Company has teamed up with Spinneybeck Leather to bring you The Taylor Spinneybeck Alliance. **Through this program, Volo, Andes, and Velluto Pelle from Spinneybeck are standard on all Taylor seating.** These leathers are graded directly into the Taylor Chair price list (Grade L3). Ordering is made easy because all it takes is a single purchase order. Leather samples are available directly through Spinneybeck at 1-800-482-7777.

NOTE: For Spinneybeck leathers not graded-in, please contact Customer Service for pricing.

Volo Leather (Grade L3)

Leather Specifications

Content:	Corrected Grain, Aniline Dyed
Thickness (Weight):	1.1 mm (2.75 oz.)
Size:	55 sq. ft. per hide
Finish:	Durable, breathable, protective

Performance Characteristics (Tests)

Light Fastness (AATCC Method 16 Option E, 72 Hours):	Class 4
Crocking (ASTM D-5053):	Class 4-5 (Dry); Class 4 (Wet)
Abrasion (ASTM D-3884):	2,000+ cycles
Flex (ASTM D-2097):	70,000 cycles

Tearing Strength, Double Hole

(FTMS 311, Method 2151):	40 lbs.
--------------------------	---------

Breaking Force

(FTMS 311, Method 2031):	250 lbs.
--------------------------	----------

Elongation

(FTMS 311, Method 2031):	30-50% at 50 lbs.
--------------------------	-------------------

Flammability (Passed the following tests)

California Technical Bulletin 117:	Complies
Boston Fire Dept., BFD IX-1:	Complies
Cigarette Ignition Resistance (NFPA-260):	Class I

Surface Burning Characteristics

of Building Materials (ASTM E84):	Class II (Class I with flame treatment)
-----------------------------------	---

NOTE: Has been successfully used in CAL 133 applications with Fireguard F187 fire backer material.

Andes Leather • Velluto Pelle Leather (Grade L3)

Leather Specifications

Content:	Lightly Enhanced, Aniline Dyed
Thickness (Weight):	1.0 mm (2.50 oz.)
Size:	55 sq. ft. per hide
Finish:	Durable, breathable, protective

Performance Characteristics (Tests)

Light Fastness (AATCC Method 16 Option E, 72 Hours):	Class 4
Crocking (ASTM D-5053):	Class 4-5 (Dry); Class 4 (Wet)
Abrasion (ASTM D-3884):	1,500+ cycles
Flex (ASTM D-2097):	70,000 cycles

Tearing Strength, Double Hole

(FTMS 311, Method 2151):	25 lbs.
--------------------------	---------

GENERAL INFORMATION | UPHOLSTERY & LEATHER

Andes Leather • Velluto Pelle Leather (Grade L3) - continued

Breaking Force

(FTMS 311, Method 2031): 150 lbs.

Elongation

(FTMS 311, Method 2031): 30-50% at 50 lbs.

Flammability (Passed the following tests)

California Technical

Bulletin 117: Complies

Boston Fire Dept., BFD IX-1: Complies

Cigarette Ignition Resistance

(NFPA-260): Class I

Surface Burning Characteristics

of Building Materials

Class II

(ASTM E84):

(Class I with flame treatment)

Nord Arch

Complies

NOTE: Has been successfully used in CAL 133 applications with Fireguard F187 fire backer material.

Leather Maintenance

It is recommended that leather is occasionally vacuumed or dusted, wiped with a mild solution of soapy water (not detergent), followed with a clean damp cloth, and allowed to air dry. Do not dry damp areas with a hair dryer. Commercial cleaning products, such as all-purpose household cleaners, saddle soaps, dressings, and solvents are not recommended. Leather should not be scrubbed, as the abrasion may damage its protective coatings.

Logo Embossing and Embroidery

Through state-of-the-art techniques, Taylor Chair can emboss or embroider your corporate or organizational logo on most Taylor seating models. A gold or silver foil logo can be embossed on Taylor seating upholstered in leather, as well as most faux leathers. Colored embroidery of a logo is available on fabric or leather upholstery.



To order, please e-mail **camera-ready artwork** of your logo to Customer Service and provide the following information:

- overall size of logo
- exact logo position on the inside or outside back
- color selected (gold or silver for foil embossing or PMS colors for embroidery)

There is a minimum quantity requirement of 4 seating units and only one logo will be applied to each chair. With respect to multiple seating units (i.e., 2111-3S), each seat is considered a separate chair for embossing and embroidery purposes. Pricing is as follows:

Embossed Logo Pricing:

Quantity of Chairs	Embossing Net Price Per Chair
Set-Up Fee (one time, non-refundable plate charge)	\$250 net (per logo)
4	50.00
5-8	45.00
9-12	40.00
13-16	35.00
17-20	30.00
21 or more	25.00

Embroidered Logo Pricing:



Quantity of Chairs	Embroidery Net Price Per Chair
Set-Up Fee (one time, non-refundable plate charge)	\$400 net (per logo)
4	\$85.00
5-8	75.00
9-12	60.00
13-16	50.00
17-20	45.00
21 or more	40.00

Flammability Codes

Unless otherwise noted by our alliance partners, all Taylor seating upholstered in Knoll Textiles, Maharam, Momentum, and Spinneybeck Leather complies with the State of California Technical Bulletin 117, Section E. To comply with more stringent standards of California Technical Bulletin 133 and Boston Fire Department BFD IX-1, a fire retardant foam is used.

For compliance of seating upholstered with a COM cover, please send a 10" x 10" sample of the cover with information regarding its fiber content and flammability rating. These orders are subject to acceptance by Taylor Chair. If laboratory certification is required for a particular model with a certain upholstery cover, in addition to the cost of the seating unit and the upcharge for the fire retardant foam, there will be an additional \$750 (net) upcharge for the burn test, freight, and video.

Refer to the table on the next page for the list upcharge for compliance with these more stringent standards.

GENERAL INFORMATION | FINISHES

Series	List Upcharge	Series	List Upcharge
2804R	\$90.00	Hampton sofa	\$795.00
2806 2808*	120.00	Judge	250.00
2814 2816*	120.00	Lexi club	220.00
2818	120.00	Lexi settee	355.00
2819	90.00	Lydia club	220.00
2831*	310.00	Lydia settee	355.00
2860*	385.00	Maxwell club	395.00
2880*	550.00	Maxwell settee	615.00
Arlington	230.00	Maxwell sofa	795.00
Aurora	230.00	Metro club	395.00
Bella	95.00	Metro settee	615.00
Bentley	135.00	Metro sofa	795.00
Classic 7612	110.00	Moselle	90.00
Classic 7613	90.00	Orbit middle	275.00
Classic 7614	110.00	Orbit left, right	275.00
Classic 8114	110.00	Ottomans	105.00
City	95.00	Parker	225.00
Cosmo club	210.00	Savannah club	395.00
Cosmo settee	315.00	Savannah settee	615.00
Cosmo sofa	550.00	Savannah sofa	795.00
Crawford	95.00	Shelby club	395.00
Crescent	95.00	Shelby settee	615.00
Elwood club	360.00	Shelby sofa	795.00
Elwood settee	610.00	Traditional Executive*	250.00
Elwood sofa	770.00	Triax	95.00
Hampton armless	325.00	Ventura	230.00
Hampton club	395.00	Zoe per seat	110.00
Hampton settee	615.00	Zoe synchro-tilt	195.00

*NOTE: Tufted versions will not comply with more stringent standards.

Standard Finishes

The standard Taylor finishes are listed below. Please specify the finish at the time of order.

RCL	Royal Cherry*	CML	Clear Maple
LWL	Light Walnut*	COL	Clear Oak
ESP	Espresso*	CHY	Cherry
MHL	Mahogany*	AMB	Amber
SMK	Smoke*	BLK	Black*

*NOTE: These finishes are available on those selected seating models that are designated "Available in medium and dark Taylor finishes only."

Taylor Chair offers high quality lacquer and oil finishes. Careful attention is paid to the finishing process, thus emphasizing the natural beauty of the wood. **The finish samples provided by Taylor Chair represent the average color of the finish.** Finishes may vary because of a variety of reasons (i.e., normal variations in wood grain, texture and density). Taylor Chair cannot accept responsibility for the finish to remain true over a period of time.

Special Finishes

Taylor Chair seating and tables are available with special finishes to match **the color** (as closely as possible) of existing woodwork, architectural details, other manufacturer's products, or other special conditions. Taylor Chair, however, cannot match the unique grain pattern of a particular species of wood. A finish sample must be submitted with your order to the Customer Service Department. On large orders, a counter sample will be developed and returned to you for approval. **Production will begin upon receipt of your written approval of the sample. If special finishes are required to match your sample, a one time, per color formulation fee of \$95 (net) plus an upcharge of \$30 (net) per chair will be charged. For orders of 12 or more chairs, the \$30 (net) per chair upcharge will be waived in most cases. Please contact Customer Service.** Color lacquer finishes are not recommended. With respect to multiple seating units (i.e., 2111-3S), each seat is considered a separate chair for special finish purposes.

If your special finish order involves both Taylor Chair and Taylor Desk products, both Customer Service Departments should be notified to ensure proper coordination of the special finish sample. Orders for discontinued finishes will be treated as special finishes and are subject to special finish upcharges, but not color formulation fees.

BASES

Certain bases may be substituted at the time of the order at no upcharge. If an alternate base is available, such base will be listed in the "Dimensions" information for that particular seating model. For a complete list of optional bases, please call the Customer Service Department. All bases are 5-star, solid wood caps over a steel structure. A black, solid, plastic composite base is also available. To specify an alternate base, add the appropriate number suffix to the seating model number, which denotes the optional base (i.e., 9720.5-PF-1705).

All swivel and posture chairs are equipped with standard, dual-wheel carpet casters.

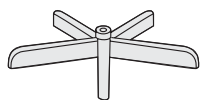

405
Specify Finish

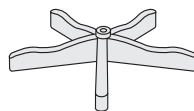

1405
Specify Finish

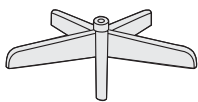

705
Specify Finish



1705
Black, Solid, Plastic Composite

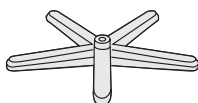

1205
Specify Finish



1805
Polished Aluminum
***Add \$95 list

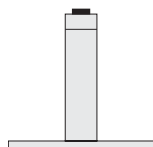

Jury Base

A slim line jury base can be supplied on any swivel chair. Jury base chairs can be self return or non-self return with finish options of Black or Brown (baked enamel). These bases are made to individual specifications per order. **Please contact Customer Service for assistance when specifying and for pricing.**

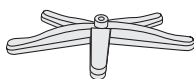

1905
Specify Finish
***Add \$95 list

5 ROOMS | 15 DAYS FAST SHIP PROGRAM

General Information

All fast ship orders will be scheduled for shipment within 15 business days after the date of order entry. All fast ship orders must be mailed, e-mailed, or faxed to:

The Taylor Chair Company
One Taylor Parkway
Bedford, Ohio 44146
Phone: 440-232-0700
Fax: 440-439-6720
E-Mail: info@thetaylorcompanies.com

All orders are subject to acceptance by The Taylor Companies and **must be marked "Fast Ship" or "5|15."** Fast ship orders will be entered only after receipt of all necessary product information, receipt of upholstery cover, and approval of credit. Phone orders must be confirmed in writing by fax or e-mail before they will be released to the factory.

Fast ship orders will be ready to ship on the date acknowledged, which will be 15 business days after order entry. On rare occasions, delivery and shipping schedules may result in actual shipping of orders at a later date.

Available factory capacity for fast ship is filled by orders received on a "first come, first serve" basis. If the normal fast ship lead time is not available for your order because capacity has been filled, you will be notified immediately and advised of the earliest ready-to-ship date.

Cancellations

All fast ship orders are considered firm orders once entered and are not subject to cancellation.

Quantity Limitations

Each fast ship order is limited to an aggregate total of 25 seating items and 20 casegood pieces (including occasional tables), whether it includes one model or a combination of several models. Individual orders that exceed this limitation may not be divided in order to qualify as a fast ship order.

Freight

Please refer to pages 4-5 for routing and freight information.

Products

Only those occasional tables and seating models marked with the following logo are available in the 5|15 Fast Ship Program:



Upholstery

Fast ship orders may be upholstered in:

- Spinneybeck Leather (Volo, Andes, Velluto Pelle)
- Taylor Leathers: Dakota or Taylor
- Knoll Textiles, Maharam, or Momentum
- Customer's Own Material (COM)
- Customer's Own Leather (COL)

Fast ship orders may be shipped partial as covers are received unless otherwise specified. Should a Knoll Textile, Maharam, Momentum, or COM fabric not be suitable for upholstery, notification will be provided before such material is cut. Taylor will not assume any responsibility for manufacturing delays caused by Spinneybeck, Knoll Textiles, Maharam, Momentum, COM, or COL delivery or for the durability, upholstery appearance, or other qualities of these fabrics and leathers. Ship your COM/COL prepaid to:

Ship your COM/COL prepaid to:

The Taylor Chair Company
One Taylor Parkway
Bedford, Ohio 44146

Mark packages with:

- "Fast Ship" or "5|15"
- Your name and order number
- Model # of upholstered pieces upon which cover is to be applied

Finish

The following Taylor finishes are available on fast ship orders. **Special finishes will not be available for fast ship orders.**

RCL	Royal Cherry	CML	Clear Maple
LWL	Light Walnut	COL	Clear Oak
ESP	Espresso	CHY	Cherry
MHL	Mahogany	AMB	Amber
SMK	Smoke	BLK	Black

Bases

Swivel chairs offered in the fast ship program are only available with the respective standard base or alternative base as listed in this price list.

To specify, include:
 • Model Number
 • Wood Finish
 • Fabric | Leather
 • Quantity

- Wood Finishes**
- RCL Royal Cherry
 - LWL Light Walnut
 - ESP Espresso
 - MHL Mahogany
 - SMK Smoke
 - CML Clear Maple
 - COL Clear Oak
 - CHY Cherry
 - AMB Amber
 - BLK Black

Graded-In Fabric | Leather
 Specific grades for fabrics and leathers can be found on the separate grade cards found in your Taylor binder. For fabric and leather patterns not graded-in, please contact Customer Service for pricing.

Dimensions
 Dimensions listed in this price book are in inches and approximate.

Freight
 Zone list pricing includes freight prepaid by Taylor for delivery to one destination only within the zone. See pg. 5 for details.

Large Order Freight Discount
 For orders with 20 units or more, please contact Customer Service for pricing.

Minimum Prepaid Freight Charges
 Orders with 4 or less guest chairs will be charged \$95 list per order.

5|15

Five Rooms in Fifteen Days
 Seating marked with this logo is a part of Taylor's "Five Rooms in Fifteen Days" program. Refer to page 11 for details.

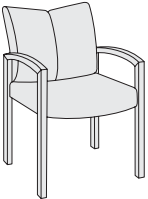
Model	Dimensions	Zone	COM	A	B	C	D	COL	L1	L2	L3	
2111 Zoe 	Width	23"	Will Call	720	845	950	1055	1305	845	1005	1105	1305
	Depth	25½"	Zone 1	805	930	1035	1140	1390	930	1090	1190	1390
	Height	34½"	Zone 2	815	940	1045	1150	1400	940	1100	1200	1400
	Seat Height	18"	Zone 3	820	945	1050	1155	1405	945	1105	1205	1405
	Seat Depth	19¼"	Zone 4	830	955	1060	1165	1415	955	1115	1215	1415
	Arm Height	25¾"	Product Notes: Optional sled base - add \$60 list, please specify. Available in all Taylor finishes.									
	Width/B Arms	20"	Two-tone upholstery applications will be priced at the higher of the two price grades. If two fabrics from the same price grade are used, item will be priced at the next higher price grade. If two COMs are used, item will be priced at the COL price grade.									
	COM	2¼ yds.										
	COL	31 sq. ft.										
	Weight	39 lbs.										
Two-Tone COM/COL*												
COM (Outside Back) 1 yd.												
COM (Inside Back/Seat) 1¾ yds.												
COL (Outside Back) 14 sq. ft.												
COL (Inside Back/Seat) 24 sq. ft.												

Closed Back

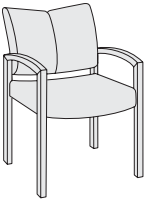
2112 Zoe 	Width	23"	Will Call	720	845	950	1055	1305	845	1005	1105	1305
	Depth	25½"	Zone 1	805	930	1035	1140	1390	930	1090	1190	1390
	Height	34½"	Zone 2	815	940	1045	1150	1400	940	1100	1200	1400
	Seat Height	18"	Zone 3	820	945	1050	1155	1405	945	1105	1205	1405
	Seat Depth	19¼"	Zone 4	830	955	1060	1165	1415	955	1115	1215	1415
	Arm Height	25¾"	Product Notes: Optional sled base - add \$60 list, please specify. Available in all Taylor finishes.									
	Width/B Arms	20"	Two-tone upholstery applications will be priced at the higher of the two price grades. If two fabrics from the same price grade are used, item will be priced at the next higher price grade. If two COMs are used, item will be priced at the COL price grade.									
	COM	2¼ yds.										
	COL	31 sq. ft.										
	Weight	39 lbs.										
Two-Tone COM/COL*												
COM (Outside Back) 1 yd.												
COM (Inside Back/Seat) 1¾ yds.												
COL (Outside Back) 14 sq. ft.												
COL (Inside Back/Seat) 24 sq. ft.												

Crumb Sweep

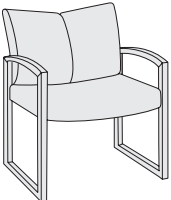
2113 Zoe 	Width	29¼"	Will Call	915	1080	1215	1360	1680	1080	1290	1430	1680
	Depth	25½"	Zone 1	1045	1210	1345	1490	1810	1210	1420	1560	1810
	Height	34½"	Zone 2	1065	1230	1365	1510	1830	1230	1440	1580	1830
	Seat Height	18"	Zone 3	1070	1235	1370	1515	1835	1235	1445	1585	1835
	Seat Depth	19¼"	Zone 4	1080	1245	1380	1525	1845	1245	1455	1595	1845
	Arm Height	25¾"	Product Notes: Available in all Taylor finishes.									
	Width/B Arms	26"	Two-tone upholstery applications will be priced at the higher of the two price grades. If two fabrics from the same price grade are used, item will be priced at the next higher price grade. If two COMs are used, item will be priced at the COL price grade.									
	COM	2¾ yds.										
	COL	39 sq. ft.										
	Weight	42 lbs.										
Two-Tone COM/COL*												
COM (Outside Back) 1 yd.												
COM (Inside Back/Seat) 2½ yds.												
COL (Outside Back) 14 sq. ft.												
COL (Inside Back/Seat) 31 sq. ft.												

Bariatric
 (Available Oct. 2007)

5 | 15

To specify, include:

- Model Number
- Wood Finish
- Fabric | Leather
- Quantity

Wood Finishes

- RCL Royal Cherry
- LWL Light Walnut
- ESP Espresso
- MHL Mahogany
- SMK Smoke
- CML Clear Maple
- COL Clear Oak
- CHY Cherry
- AMB Amber
- BLK Black

Graded-In Fabric | Leather

Specific grades for fabrics and leathers can be found on the separate grade cards found in your Taylor binder. For fabric and leather patterns not graded-in, please contact Customer Service for pricing.

Dimensions

Dimensions listed in this price book are in inches and approximate.

Freight

Zone list pricing includes freight prepaid by Taylor for delivery to one destination only within the zone. See pg. 5 for details.

Large Order Freight Discount

For orders with 20 units or more, please contact Customer Service for pricing.

Minimum Prepaid Freight Charges

Orders with 4 or less guest chairs will be charged **\$95 list per order**.

Five Rooms in Fifteen Days

Seating marked with this logo is a part of Taylor's "Five Rooms in Fifteen Days" program. Refer to page 11 for details.

Model	Dimensions	Zone	COM	A	B	C	D	COL	L1	L2	L3	
7414 Crawford	Width	23"	Will Call	765	855	920	990	1230	855	950	1060	1230
	Depth	24"	Zone 1	850	940	1005	1075	1315	940	1035	1145	1315
	Height	32"	Zone 2	860	950	1015	1085	1325	950	1045	1155	1325
	Seat Height	18½"	Zone 3	865	955	1020	1090	1330	955	1050	1160	1330
	Seat Depth	18"	Zone 4	875	965	1030	1100	1340	965	1060	1170	1340
	Arm Height	26"										
	Width/B Arms	20½"										
	COM	1¾ yds.										
	COL	24 sq. ft.										
	Weight	35 lbs.										

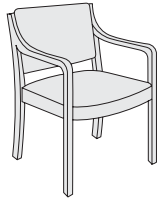

Open Back,
Exposed Side Rails

Product Notes:
Available in all Taylor finishes.

Model	Dimensions	Zone	COM	A	B	C	D	COL	L1	L2	L3	
7415 Crawford	Width	23"	Will Call	805	890	950	1025	1280	890	980	1090	1280
	Depth	24"	Zone 1	890	975	1035	1110	1365	975	1065	1175	1365
	Height	32"	Zone 2	900	985	1045	1120	1375	985	1075	1185	1375
	Seat Height	18½"	Zone 3	905	990	1050	1125	1380	990	1080	1190	1380
	Seat Depth	18"	Zone 4	915	1000	1060	1135	1390	1000	1090	1200	1390
	Arm Height	26"										
	Width/B Arms	20½"										
	COM	2 yds.										
	COL	27 sq. ft.										
	Weight	35 lbs.										

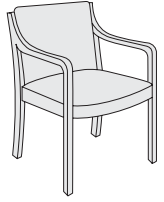

Closed Back,
Exposed Side Rails

Product Notes:
Available in all Taylor finishes.

Model	Dimensions	Zone	COM	A	B	C	D	COL	L1	L2	L3	
7415PA Crawford	Width	23"	Will Call	915	1000	1060	1135	1460	1000	1090	1205	1460
	Depth	24"	Zone 1	1000	1085	1145	1220	1545	1085	1175	1290	1545
	Height	32"	Zone 2	1010	1095	1155	1230	1555	1095	1185	1300	1555
	Seat Height	18½"	Zone 3	1015	1100	1160	1235	1560	1100	1190	1305	1560
	Seat Depth	18"	Zone 4	1025	1110	1170	1245	1570	1110	1200	1315	1570
	Arm Height	26"										
	Width/B Arms	20½"										
	COM	2¼ yds.										
	COL	30 sq. ft.										
	Weight	39 lbs.										

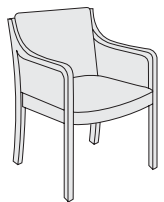

Closed Back, Panel Arms,
Exposed Side Rails

Product Notes:
Available in all Taylor finishes.

To specify, include:

- Model Number
- Wood Finish
- Fabric | Leather
- Quantity

Wood Finishes

- RCL Royal Cherry
- LWL Light Walnut
- ESP Espresso
- MHL Mahogany
- SMK Smoke
- CML Clear Maple
- COL Clear Oak
- CHY Cherry
- AMB Amber
- BLK Black

Graded-In Fabric | Leather

Specific grades for fabrics and leathers can be found on the separate grade cards found in your Taylor binder. For fabric and leather patterns not graded-in, please contact Customer Service for pricing.

Dimensions

Dimensions listed in this price book are in inches and approximate.

Freight

Zone list pricing includes freight prepaid by Taylor for delivery to one destination only within the zone. See pg. 5 for details.

Large Order Freight Discount

For orders with 20 units or more, please contact Customer Service for pricing.

Minimum Prepaid Freight Charges

Orders with 4 or less guest chairs will be charged \$95 list per order.

5 | 15

Five Rooms in Fifteen Days

Seating marked with this logo is a part of Taylor's "Five Rooms in Fifteen Days" program. Refer to page 11 for details.

Model	Dimensions	Zone	COM	A	B	C	D	COL	L1	L2	L3	
7416 Crawford	Width	23"	Will Call	765	855	920	990	1230	855	950	1060	1230
	Depth	24"	Zone 1	850	940	1005	1075	1315	940	1035	1145	1315
	Height	32"	Zone 2	860	950	1015	1085	1325	950	1045	1155	1325
	Seat Height	18½"	Zone 3	865	955	1020	1090	1330	955	1050	1160	1330
	Seat Depth	18"	Zone 4	875	965	1030	1100	1340	965	1060	1170	1340
	Arm Height	26"	Product Notes:									
	Width/B Arms	20½"	Available in all Taylor finishes.									
	COM	1¾ yds.										
	COL	24 sq. ft.										
	Weight	35 lbs.										

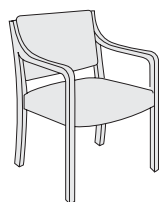

Open Back

Model	Dimensions	Zone	COM	A	B	C	D	COL	L1	L2	L3	
7417 Crawford	Width	23"	Will Call	805	890	950	1025	1280	890	980	1090	1280
	Depth	24"	Zone 1	890	975	1035	1110	1365	975	1065	1175	1365
	Height	32"	Zone 2	900	985	1045	1120	1375	985	1075	1185	1375
	Seat Height	18½"	Zone 3	905	990	1050	1125	1380	990	1080	1190	1380
	Seat Depth	18"	Zone 4	915	1000	1060	1135	1390	1000	1090	1200	1390
	Arm Height	26"	Product Notes:									
	Width/B Arms	20½"	Available in all Taylor finishes.									
	COM	2 yds.										
	COL	27 sq. ft.										
	Weight	35 lbs.										

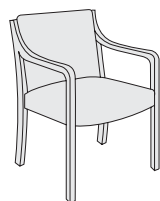

Closed Back

Model	Dimensions	Zone	COM	A	B	C	D	COL	L1	L2	L3	
7417PA Crawford	Width	23"	Will Call	915	1000	1060	1135	1460	1000	1090	1205	1460
	Depth	24"	Zone 1	1000	1085	1145	1220	1545	1085	1175	1290	1545
	Height	32"	Zone 2	1010	1095	1155	1230	1555	1095	1185	1300	1555
	Seat Height	18½"	Zone 3	1015	1100	1160	1235	1560	1100	1190	1305	1560
	Seat Depth	18"	Zone 4	1025	1110	1170	1245	1570	1110	1200	1315	1570
	Arm Height	26"	Product Notes:									
	Width/B Arms	20½"	Available in all Taylor finishes.									
	COM	2¼ yds.										
	COL	30 sq. ft.										
	Weight	39 lbs.										

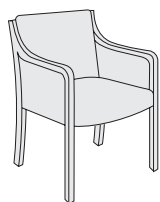

Closed Back, Panel Arms

To specify, include:

- Model Number
- Wood Finish
- Fabric | Leather
- Quantity

Wood Finishes

- RCL Royal Cherry
- LWL Light Walnut
- ESP Espresso
- MHL Mahogany
- SMK Smoke
- CML Clear Maple
- COL Clear Oak
- CHY Cherry
- AMB Amber
- BLK Black

Graded-In Fabric | Leather
 Specific grades for fabrics and leathers can be found on the separate grade cards found in your Taylor binder. For fabric and leather patterns not graded-in, please contact Customer Service for pricing.

Dimensions
 Dimensions listed in this price book are in inches and approximate.

Freight
 Zone list pricing includes freight prepaid by Taylor for delivery to one destination only within the zone. See pg. 5 for details.

Large Order Freight Discount
 For orders with 20 units or more, please contact Customer Service for pricing.

Minimum Prepaid Freight Charges
 Orders with 4 or less guest chairs will be charged \$95 list per order.

5 | 15

Five Rooms in Fifteen Days
 Seating marked with this logo is a part of Taylor's "Five Rooms in Fifteen Days" program. Refer to page 11 for details.

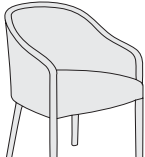
Model	Dimensions	Zone	COM	A	B	C	D	COL	L1	L2	L3	
7612 Classic	 <p>5 15</p> <p>Width 23¼" Depth 25" Height 32¾" Seat Height 18½" Seat Depth 18" Arm Height 25" Width/B Arms 20" COM 3 yds. COL 41 sq. ft. Weight 35 lbs.</p>	Will Call	685	780	830	905	1195	780	870	965	1195	
		Zone 1	770	865	915	990	1280	865	955	1050	1280	
		Zone 2	780	875	925	1000	1290	875	965	1060	1290	
		Zone 3	785	880	930	1005	1295	880	970	1065	1295	
		Zone 4	795	890	940	1015	1305	890	980	1075	1305	
		Product Notes: Available in all Taylor finishes.										

Closed Back,
Steam Bent Top Rail

Model	Dimensions	Zone	COM	A	B	C	D	COL	L1	L2	L3	
7613 Classic	 <p>5 15</p> <p>Width 23¼" Depth 25" Height 32¾" Seat Height 18½" Seat Depth 18" Arm Height 25" Width/B Arms 20" COM 2 yds. COL 27 sq. ft. Weight 32 lbs.</p>	Will Call	640	720	785	855	1085	720	820	920	1085	
		Zone 1	725	805	870	940	1170	805	905	1005	1170	
		Zone 2	735	815	880	950	1180	815	915	1015	1180	
		Zone 3	740	820	885	955	1185	820	920	1020	1185	
		Zone 4	750	830	895	965	1195	830	930	1030	1195	
		Product Notes: Available in all Taylor finishes.										

Open Back,
Steam Bent Top Rail

Model	Dimensions	Zone	COM	A	B	C	D	COL	L1	L2	L3	
7614 Classic	 <p>5 15</p> <p>Width 25" Depth 26" Height 32½" Seat Height 18½" Seat Depth 18" Arm Height 25" Width/B Arms 19½" COM 3 yds. COL 41 sq. ft. Weight 35 lbs.</p>	Will Call	640	720	785	855	1085	720	820	920	1085	
		Zone 1	725	805	870	940	1170	805	905	1005	1170	
		Zone 2	735	815	880	950	1180	815	915	1015	1180	
		Zone 3	740	820	885	955	1185	820	920	1020	1185	
		Zone 4	750	830	895	965	1195	830	930	1030	1195	
		Product Notes: Available in all Taylor finishes.										

Fully Upholstered

To specify, include:

- Model Number
- Wood Finish
- Fabric | Leather
- Quantity

Wood Finishes

- RCL Royal Cherry
- LWL Light Walnut
- ESP Espresso
- MHL Mahogany
- SMK Smoke
- CML Clear Maple
- COL Clear Oak
- CHY Cherry
- AMB Amber
- BLK Black

Graded-In Fabric | Leather

Specific grades for fabrics and leathers can be found on the separate grade cards found in your Taylor binder. For fabric and leather patterns not graded-in, please contact Customer Service for pricing.

Dimensions

Dimensions listed in this price book are in inches and approximate.

Freight

Zone list pricing includes freight prepaid by Taylor for delivery to one destination only within the zone. See pg. 5 for details.

Large Order Freight Discount

For orders with 20 units or more, please contact Customer Service for pricing.

Minimum Prepaid Freight Charges

Orders with 4 or less guest chairs will be charged \$95 list per order.

5 | 15

Five Rooms in Fifteen Days

Seating marked with this logo is a part of Taylor's "Five Rooms in Fifteen Days" program. Refer to page 11 for details.

Model	Dimensions	Zone	COM	A	B	C	D	COL	L1	L2	L3	
8114 Classic	Width	24¼"	Will Call	1055	1215	1355	1500	1855	1215	1430	1575	1855
	Depth	24"	Zone 1	1140	1300	1440	1585	1940	1300	1515	1660	1940
	Height	32"	Zone 2	1150	1310	1450	1595	1950	1310	1525	1670	1950
	Seat Height	18"	Zone 3	1155	1315	1455	1600	1955	1315	1530	1675	1955
	Seat Depth	18½"	Zone 4	1165	1325	1465	1610	1965	1325	1540	1685	1965
	Arm Height	25¼"										
	Width/B Arms	18½"										
	COM	2¾ yds.										
	COL	38 sq. ft.										
	Weight	36 lbs.										

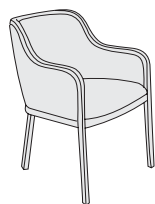

Steam Bent Top Rail

Product Notes:
Not available in vinyl upholstery.
Available in all Taylor finishes.

Model	Dimensions	Zone	COM	A	B	C	D	COL	L1	L2	L3	
9015 Triax	Width	24"	Will Call	845	960	1065	1170	1390	960	1115	1220	1390
	Depth	25¼"	Zone 1	930	1045	1150	1255	1475	1045	1200	1305	1475
	Height	32"	Zone 2	940	1055	1160	1265	1485	1055	1210	1315	1485
	Seat Height	18"	Zone 3	945	1060	1165	1270	1490	1060	1215	1320	1490
	Seat Depth	18½"	Zone 4	955	1070	1175	1280	1500	1070	1225	1330	1500
	Arm Height	25½"										
	Width/B Arms	19¾"										
	COM	2 yds.										
	COL	27 sq. ft.										
	Weight	38 lbs.										

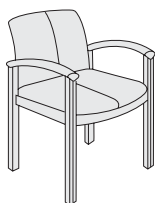

Exposed Side Rails

Product Notes:
Optional two-tone finish - add \$90 list, please specify.
Available in all Taylor finishes.

Model	Dimensions	Zone	COM	A	B	C	D	COL	L1	L2	L3	
9015-N Triax	Width	24"	Will Call	845	960	1065	1170	1390	960	1115	1220	1390
	Depth	25¼"	Zone 1	930	1045	1150	1255	1475	1045	1200	1305	1475
	Height	32"	Zone 2	940	1055	1160	1265	1485	1055	1210	1315	1485
	Seat Height	18"	Zone 3	945	1060	1165	1270	1490	1060	1215	1320	1490
	Seat Depth	18½"	Zone 4	955	1070	1175	1280	1500	1070	1225	1330	1500
	Arm Height	25½"										
	Width/B Arms	19¾"										
	COM	2 yds.										
	COL	27 sq. ft.										
	Weight	38 lbs.										

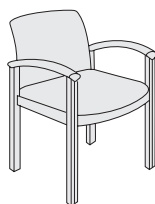

No Center Seam, Exposed Side Rails

Product Notes:
Optional two-tone finish - add \$90 list, please specify.
Available in all Taylor finishes.

To specify, include:

- Model Number
- Wood Finish
- Fabric | Leather
- Quantity

Wood Finishes

- RCL Royal Cherry
- LWL Light Walnut
- ESP Espresso
- MHL Mahogany
- SMK Smoke
- CML Clear Maple
- COL Clear Oak
- CHY Cherry
- AMB Amber
- BLK Black

Graded-In Fabric | Leather

Specific grades for fabrics and leathers can be found on the separate grade cards found in your Taylor binder. For fabric and leather patterns not graded-in, please contact Customer Service for pricing.

Dimensions

Dimensions listed in this price book are in inches and approximate.

Freight

Zone list pricing includes freight prepaid by Taylor for delivery to one destination only within the zone. See pg. 5 for details.

Large Order Freight Discount

For orders with 20 units or more, please contact Customer Service for pricing.



Minimum Prepaid Freight Charges

Orders with 4 or less guest chairs will be charged \$95 list per order.

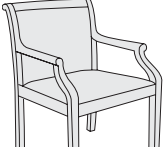

5|15

Five Rooms in Fifteen Days

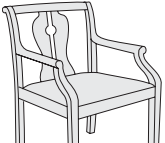

Seating marked with this logo is a part of Taylor's "Five Rooms in Fifteen Days" program. Refer to page 11 for details.

Model	Dimensions	Zone	COM	A	B	C	D	COL	L1	L2	L3		
9316 Moselle 	 Width 23¾" Depth 27" Height 32¾" Seat Height 18½" Seat Depth 19¼" Arm Height 24½" Width/B Arms 20½" COM 1¾ yds. COL 24 sq. ft. Weight 34 lbs.	Will Call	845	930	1015	1105	1315	930	1060	1155	1315		
		Zone 1	930	1015	1100	1190	1400	1015	1145	1240	1400		
		Zone 2	940	1025	1110	1200	1410	1025	1155	1250	1410		
		Zone 3	945	1030	1115	1205	1415	1030	1160	1255	1415		
		Zone 4	955	1040	1125	1215	1425	1040	1170	1265	1425		
		Product Notes:											
		Not available in vinyl upholstery. Available in all Taylor finishes.											

Closed Back,
Exposed Side Rails

9317 Moselle 	 Width 23¾" Depth 27" Height 32¾" Seat Height 18½" Seat Depth 20¾" Arm Height 24½" Width/B Arms 20½" COM 1 yds. COL 14 sq. ft. Weight 34 lbs.	Will Call	905	985	1075	1170	1305	985	1120	1215	1305		
		Zone 1	990	1070	1160	1255	1390	1070	1205	1300	1390		
		Zone 2	1000	1080	1170	1265	1400	1080	1215	1310	1400		
		Zone 3	1005	1085	1175	1270	1405	1085	1220	1315	1405		
		Zone 4	1015	1095	1185	1280	1415	1095	1230	1325	1415		
		Product Notes:											
		Available in all Taylor finishes.											

Splat Back,
Exposed Side Rails

9318 Moselle 	 Width 23¾" Depth 27" Height 32¾" Seat Height 18½" Seat Depth 20¾" Arm Height 24½" Width/B Arms 20½" COM 1 yds. COL 14 sq. ft. Weight 34 lbs.	Will Call	950	1035	1110	1215	1360	1035	1165	1270	1360		
		Zone 1	1035	1120	1195	1300	1445	1120	1250	1355	1445		
		Zone 2	1045	1130	1205	1310	1455	1130	1260	1365	1455		
		Zone 3	1050	1135	1210	1315	1460	1135	1265	1370	1460		
		Zone 4	1060	1145	1220	1325	1470	1145	1275	1380	1470		
		Product Notes:											
		Available in all Taylor finishes.											

Slat Back,
Exposed Side Rails

To specify, include:
 • Model Number
 • Wood Finish
 • Fabric | Leather
 • Quantity

- Wood Finishes**
- RCL Royal Cherry
 - LWL Light Walnut
 - ESP Espresso
 - MHL Mahogany
 - SMK Smoke
 - CML Clear Maple
 - COL Clear Oak
 - CHY Cherry
 - AMB Amber
 - BLK Black

Graded-In Fabric | Leather
 Specific grades for fabrics and leathers can be found on the separate grade cards found in your Taylor binder. For fabric and leather patterns not graded-in, please contact Customer Service for pricing.

Dimensions
 Dimensions listed in this price book are in inches and approximate.

Freight
 Zone list pricing includes freight prepaid by Taylor for delivery to one destination only within the zone. See pg. 5 for details.

Large Order Freight Discount
 For orders with 20 units or more, please contact Customer Service for pricing.

Minimum Prepaid Freight Charges
 Orders with 4 or less guest chairs will be charged \$95 list per order.

5 | 15

Five Rooms in Fifteen Days
 Seating marked with this logo is a part of Taylor's "Five Rooms in Fifteen Days" program. Refer to page 11 for details.

Model	Dimensions	Zone	COM	A	B	C	D	COL	L1	L2	L3																				
9411 City	<div style="display: flex; align-items: center;"> <div style="font-size: 24pt; font-weight: bold; margin-right: 10px;">5 15</div> <table border="0"> <tr><td>Width</td><td>22¼"</td></tr> <tr><td>Depth</td><td>25"</td></tr> <tr><td>Height</td><td>32¼"</td></tr> <tr><td>Seat Height</td><td>18½"</td></tr> <tr><td>Seat Depth</td><td>18¼"</td></tr> <tr><td>Arm Height</td><td>25½"</td></tr> <tr><td>Width/B Arms</td><td>19½"</td></tr> <tr><td>COM</td><td>1¾ yds.</td></tr> <tr><td>COL</td><td>24 sq. ft.</td></tr> <tr><td>Weight</td><td>28 lbs.</td></tr> </table> </div>	Width	22¼"	Depth	25"	Height	32¼"	Seat Height	18½"	Seat Depth	18¼"	Arm Height	25½"	Width/B Arms	19½"	COM	1¾ yds.	COL	24 sq. ft.	Weight	28 lbs.	Will Call	640	720	805	890	1085	720	845	930	1085
		Width	22¼"																												
		Depth	25"																												
		Height	32¼"																												
		Seat Height	18½"																												
		Seat Depth	18¼"																												
		Arm Height	25½"																												
		Width/B Arms	19½"																												
		COM	1¾ yds.																												
		COL	24 sq. ft.																												
Weight	28 lbs.																														
Zone 1	725	805	890	975	1170	805	930	1015	1170																						
Zone 2	735	815	900	985	1180	815	940	1025	1180																						
Zone 3	740	820	905	990	1185	820	945	1030	1185																						
Zone 4	750	830	915	1000	1195	830	955	1040	1195																						
Product Notes: Not available in vinyl upholstery. Available in all Taylor finishes.																															

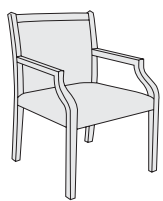

Closed Back

Model	Dimensions	Zone	COM	A	B	C	D	COL	L1	L2	L3																				
9412 City	<div style="display: flex; align-items: center;"> <div style="font-size: 24pt; font-weight: bold; margin-right: 10px;">5 15</div> <table border="0"> <tr><td>Width</td><td>22¼"</td></tr> <tr><td>Depth</td><td>25"</td></tr> <tr><td>Height</td><td>32¼"</td></tr> <tr><td>Seat Height</td><td>18½"</td></tr> <tr><td>Seat Depth</td><td>18¼"</td></tr> <tr><td>Arm Height</td><td>25½"</td></tr> <tr><td>Width/B Arms</td><td>19½"</td></tr> <tr><td>COM</td><td>1½ yds.</td></tr> <tr><td>COL</td><td>20 sq. ft.</td></tr> <tr><td>Weight</td><td>27 lbs.</td></tr> </table> </div>	Width	22¼"	Depth	25"	Height	32¼"	Seat Height	18½"	Seat Depth	18¼"	Arm Height	25½"	Width/B Arms	19½"	COM	1½ yds.	COL	20 sq. ft.	Weight	27 lbs.	Will Call	660	745	825	910	1085	745	870	950	1085
		Width	22¼"																												
		Depth	25"																												
		Height	32¼"																												
		Seat Height	18½"																												
		Seat Depth	18¼"																												
		Arm Height	25½"																												
		Width/B Arms	19½"																												
		COM	1½ yds.																												
		COL	20 sq. ft.																												
Weight	27 lbs.																														
Zone 1	745	830	910	995	1170	830	955	1035	1170																						
Zone 2	755	840	920	1005	1180	840	965	1045	1180																						
Zone 3	760	845	925	1010	1185	845	970	1050	1185																						
Zone 4	770	855	935	1020	1195	855	980	1060	1195																						
Product Notes: Available in all Taylor finishes.																															

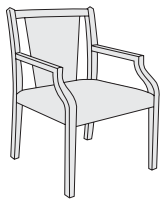

"V" Back

Model	Dimensions	Zone	COM	A	B	C	D	COL	L1	L2	L3																				
9414 City	<table border="0"> <tr><td>Width</td><td>22¼"</td></tr> <tr><td>Depth</td><td>25"</td></tr> <tr><td>Height</td><td>32¼"</td></tr> <tr><td>Seat Height</td><td>18½"</td></tr> <tr><td>Seat Depth</td><td>18¼"</td></tr> <tr><td>Arm Height</td><td>25½"</td></tr> <tr><td>Width/B Arms</td><td>19½"</td></tr> <tr><td>COM</td><td>1¾ yds.</td></tr> <tr><td>COL</td><td>24 sq. ft.</td></tr> <tr><td>Weight</td><td>29 lbs.</td></tr> </table>	Width	22¼"	Depth	25"	Height	32¼"	Seat Height	18½"	Seat Depth	18¼"	Arm Height	25½"	Width/B Arms	19½"	COM	1¾ yds.	COL	24 sq. ft.	Weight	29 lbs.	Will Call	690	765	855	945	1095	765	900	990	1095
		Width	22¼"																												
		Depth	25"																												
		Height	32¼"																												
		Seat Height	18½"																												
		Seat Depth	18¼"																												
		Arm Height	25½"																												
		Width/B Arms	19½"																												
		COM	1¾ yds.																												
		COL	24 sq. ft.																												
Weight	29 lbs.																														
Zone 1	775	850	940	1030	1180	850	985	1075	1180																						
Zone 2	785	860	950	1040	1190	860	995	1085	1190																						
Zone 3	790	865	955	1045	1195	865	1000	1090	1195																						
Zone 4	800	875	965	1055	1205	875	1010	1100	1205																						
Product Notes: Not available in vinyl upholstery. Available in all Taylor finishes.																															

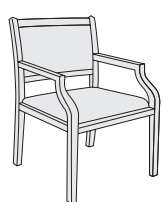

¾ Back,
Exposed Side Rails

To specify, include:

- Model Number
- Wood Finish
- Fabric | Leather
- Quantity

Wood Finishes

- RCL Royal Cherry
- LWL Light Walnut
- ESP Espresso
- MHL Mahogany
- SMK Smoke
- CML Clear Maple
- COL Clear Oak
- CHY Cherry
- AMB Amber
- BLK Black

Graded-In Fabric | Leather

Specific grades for fabrics and leathers can be found on the separate grade cards found in your Taylor binder. For fabric and leather patterns not graded-in, please contact Customer Service for pricing.

Dimensions

Dimensions listed in this price book are in inches and approximate.

Freight

Zone list pricing includes freight prepaid by Taylor for delivery to one destination only within the zone. See pg. 5 for details.

Large Order Freight Discount

For orders with 20 units or more, please contact Customer Service for pricing.



Minimum Prepaid Freight Charges

Orders with 4 or less guest chairs will be charged \$95 list per order.

5 | 15

Five Rooms in Fifteen Days

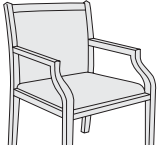
Seating marked with this logo is a part of Taylor's "Five Rooms in Fifteen Days" program. Refer to page 11 for details.

Model	Dimensions	Zone	COM	A	B	C	D	COL	L1	L2	L3		
9415 City 	 Width 22¼" Depth 25" Height 32¼" Seat Height 18½" Seat Depth 17¾" Arm Height 25½" Width/B Arms 19½" COM 1¾ yds. COL 24 sq. ft. Weight 29 lbs.	Will Call	670	745	835	925	1075	745	880	970	1075		
		Zone 1	755	830	920	1010	1160	830	965	1055	1160		
		Zone 2	765	840	930	1020	1170	840	975	1065	1170		
		Zone 3	770	845	935	1025	1175	845	980	1070	1175		
		Zone 4	780	855	945	1035	1185	855	990	1080	1185		
		Product Notes: Not available in vinyl upholstery. Available in all Taylor finishes.											

Closed Back,
Exposed Side Rails

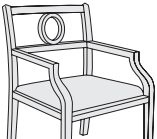
9416 City 	Width 22¼" Depth 25" Height 32¼" Seat Height 18½" Seat Depth 18" Arm Height 25½" Width/B Arms 19½" COM 1 yd. COL 12 sq. ft. Weight 28 lbs.	Will Call	675	750	840	930	1080	750	885	975	1080		
		Zone 1	760	835	925	1015	1165	835	970	1060	1165		
		Zone 2	770	845	935	1025	1175	845	980	1070	1175		
		Zone 3	775	850	940	1030	1180	850	985	1075	1180		
		Zone 4	785	860	950	1040	1190	860	995	1085	1190		
		Product Notes: Optional two-tone finish on Biedemeier Detail - add \$50 list, please specify. Available in all Taylor finishes.											

Open Back with Detail,
Exposed Side Rails

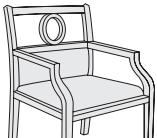
9417 City 	Width 22¼" Depth 25" Height 32¼" Seat Height 18½" Seat Depth 16¾" Arm Height 25½" Width/B Arms 19½" COM 1½ yds. COL 20 sq. ft. Weight 29 lbs.	Will Call	695	765	855	945	1090	765	900	990	1090		
		Zone 1	780	850	940	1030	1175	850	985	1075	1175		
		Zone 2	790	860	950	1040	1185	860	995	1085	1185		
		Zone 3	795	865	955	1045	1190	865	1000	1090	1190		
		Zone 4	805	875	965	1055	1200	875	1010	1100	1200		
		Product Notes: Not available in vinyl upholstery. Optional two-tone finish on Biedemeier Detail - add \$50 list, please specify. Available in all Taylor finishes.											

Closed Back with Detail,
Exposed Side Rails

To specify, include:

- Model Number
- Wood Finish
- Fabric | Leather
- Quantity

- Wood Finishes**
- RCL Royal Cherry
 - LWL Light Walnut
 - ESP Espresso
 - MHL Mahogany
 - SMK Smoke
 - CML Clear Maple
 - COL Clear Oak
 - CHY Cherry
 - AMB Amber
 - BLK Black

Graded-In Fabric | Leather
 Specific grades for fabrics and leathers can be found on the separate grade cards found in your Taylor binder. For fabric and leather patterns not graded-in, please contact Customer Service for pricing.

Dimensions
 Dimensions listed in this price book are in inches and approximate.

Freight
 Zone list pricing includes freight prepaid by Taylor for delivery to one destination only within the zone. See pg. 5 for details.

Large Order Freight Discount
 For orders with 20 units or more, please contact Customer Service for pricing.

Minimum Prepaid Freight Charges
 Orders with 4 or less guest chairs will be charged \$95 list per order.

5|15

Five Rooms in Fifteen Days
 Seating marked with this logo is a part of Taylor's "Five Rooms in Fifteen Days" program. Refer to page 11 for details.

Model	Dimensions	Zone	COM	A	B	C	D	COL	L1	L2	L3			
9711-XB Bella	 <p>Closed Back, Exposed Side Rails</p>	5 15	Width	21¼"	Will Call	680	775	855	940	1115	775	900	980	1115
			Depth	24½"	Zone 1	765	860	940	1025	1200	860	985	1065	1200
			Height	32¼"	Zone 2	775	870	950	1035	1210	870	995	1075	1210
			Seat Height	19"	Zone 3	780	875	955	1040	1215	875	1000	1080	1215
			Seat Depth	18"	Zone 4	790	885	965	1050	1225	885	1010	1090	1225
			Arm Height	27½"	Product Notes:									
			Width/B Arms	19"	Not available in vinyl upholstery.									
			COM	1¾ yds.	Available in all Taylor finishes.									
			COL	24 sq. ft.										
			Weight	33 lbs.										

Model	Dimensions	Zone	COM	A	B	C	D	COL	L1	L2	L3			
9712-XB Bella	 <p>Horizontal Slat and Open Back, Exposed Side Rails</p>	5 15	Width	21¼"	Will Call	640	730	815	900	1025	730	855	940	1025
			Depth	23"	Zone 1	725	815	900	985	1110	815	940	1025	1110
			Height	32¼"	Zone 2	735	825	910	995	1120	825	950	1035	1120
			Seat Height	19"	Zone 3	740	830	915	1000	1125	830	955	1040	1125
			Seat Depth	18"	Zone 4	750	840	925	1010	1135	840	965	1050	1135
			Arm Height	27½"	Product Notes:									
			Width/B Arms	19"	Available in all Taylor finishes.									
			COM	1 yd.										
			COL	12 sq. ft.										
			Weight	32 lbs.										

Model	Dimensions	Zone	COM	A	B	C	D	COL	L1	L2	L3			
9713-XB Bella	 <p>Horizontal Slat and Closed Back, Exposed Side Rails</p>	5 15	Width	21¼"	Will Call	680	775	855	940	1115	775	900	980	1115
			Depth	23"	Zone 1	765	860	940	1025	1200	860	985	1065	1200
			Height	32¼"	Zone 2	775	870	950	1035	1210	870	995	1075	1210
			Seat Height	19"	Zone 3	780	875	955	1040	1215	875	1000	1080	1215
			Seat Depth	18"	Zone 4	790	885	965	1050	1225	885	1010	1090	1225
			Arm Height	27½"	Product Notes:									
			Width/B Arms	19"	Not available in vinyl upholstery.									
			COM	1½ yds.	Available in all Taylor finishes.									
			COL	20 sq. ft.										
			Weight	32 lbs.										

To specify, include:

- Model Number
- Wood Finish
- Fabric | Leather
- Quantity

Wood Finishes

- RCL Royal Cherry
- LWL Light Walnut
- ESP Espresso
- MHL Mahogany
- SMK Smoke
- CML Clear Maple
- COL Clear Oak
- CHY Cherry
- AMB Amber
- BLK Black

Graded-In Fabric | Leather

Specific grades for fabrics and leathers can be found on the separate grade cards found in your Taylor binder. For fabric and leather patterns not graded-in, please contact Customer Service for pricing.

Dimensions

Dimensions listed in this price book are in inches and approximate.

Freight

Zone list pricing includes freight prepaid by Taylor for delivery to one destination only within the zone. See pg. 5 for details.

Large Order Freight Discount

For orders with 20 units or more, please contact Customer Service for pricing.

Minimum Prepaid Freight Charges

Orders with 4 or less guest chairs will be charged **\$95 list per order**.

5 | 15

Five Rooms in Fifteen Days

Seating marked with this logo is a part of Taylor's "Five Rooms in Fifteen Days" program. Refer to page 11 for details.

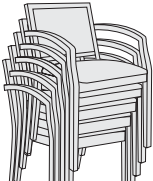
Model	Dimensions	Zone	COM	A	B	C	D	COL	L1	L2	L3		
9714 Bella 	<div style="border: 1px solid black; padding: 2px; display: inline-block;">5 15</div> Width 21½" Depth 22¼" Height 32¼" Seat Height 19" Seat Depth 18¼" Arm Height 27½" Width/B Arms 19" COM 1½ yds. COL 20 sq. ft. Weight 32 lbs.	Will Call	695	790	875	955	1120	790	915	1000	1120		
		Zone 1	780	875	960	1040	1205	875	1000	1085	1205		
		Zone 2	790	885	970	1050	1215	885	1010	1095	1215		
		Zone 3	795	890	975	1055	1220	890	1015	1100	1220		
		Zone 4	805	900	985	1065	1230	900	1025	1110	1230		
		Product Notes:											
		Not available in vinyl upholstery.											
		Available in all Taylor finishes.											

Stacks Five High

Model	Dimensions	Zone	COM	A	B	C	D	COL	L1	L2	L3		
9715 Bella 	<div style="border: 1px solid black; padding: 2px; display: inline-block;">5 15</div> Width 21¼" Depth 24½" Height 32¼" Seat Height 19" Seat Depth 18" Arm Height 27½" Width/B Arms 19" COM 1½ yds. COL 20 sq. ft. Weight 33 lbs.	Will Call	720	815	895	980	1155	815	940	1020	1155		
		Zone 1	805	900	980	1065	1240	900	1025	1105	1240		
		Zone 2	815	910	990	1075	1250	910	1035	1115	1250		
		Zone 3	820	915	995	1080	1255	915	1040	1120	1255		
		Zone 4	830	925	1005	1090	1265	925	1050	1130	1265		
		Product Notes:											
		Not available in vinyl upholstery.											
		Available in all Taylor finishes.											

¾ Back,
Exposed Side Rails

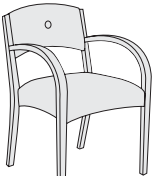
Model	Dimensions	Zone	COM	A	B	C	D	COL	L1	L2	L3		
9911 Crescent 	<div style="border: 1px solid black; padding: 2px; display: inline-block;">5 15</div> Width 22¼" Depth 24½" Height 33" Seat Height 18¾" Seat Depth 19" Arm Height 27½" Width/B Arms 19" COM 2 yds. COL 27 sq. ft. Weight 34 lbs.	Will Call	775	870	955	1050	1245	870	1005	1095	1245		
		Zone 1	860	955	1040	1135	1330	955	1090	1180	1330		
		Zone 2	870	965	1050	1145	1340	965	1100	1190	1340		
		Zone 3	875	970	1055	1150	1345	970	1105	1195	1345		
		Zone 4	885	980	1065	1160	1355	980	1115	1205	1355		
		Product Notes:											
		Available without inside/outside back bottom detail, please specify (-NB).											
		Available in all Taylor finishes.											

Open Back

To specify, include:

- Model Number
- Wood Finish
- Fabric | Leather
- Quantity

Wood Finishes

- RCL Royal Cherry
- LWL Light Walnut
- ESP Espresso
- MHL Mahogany
- SMK Smoke
- CML Clear Maple
- COL Clear Oak
- CHY Cherry
- AMB Amber
- BLK Black

Graded-In Fabric | Leather

Specific grades for fabrics and leathers can be found on the separate grade cards found in your Taylor binder. For fabric and leather patterns not graded-in, please contact Customer Service for pricing.

Dimensions

Dimensions listed in this price book are in inches and approximate.

Freight

Zone list pricing includes freight prepaid by Taylor for delivery to one destination only within the zone. See pg. 5 for details.

Large Order Freight Discount

For orders with 20 units or more, please contact Customer Service for pricing.

Minimum Prepaid Freight Charges

Orders with 4 or less guest chairs will be charged \$95 list per order.

5|15

Five Rooms in Fifteen Days

Seating marked with this logo is a part of Taylor's "Five Rooms in Fifteen Days" program. Refer to page 11 for details.

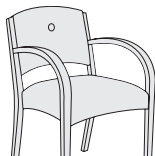
Model	Dimensions	Zone	COM	A	B	C	D	COL	L1	L2	L3		
9912 Crescent	 <p>5 15</p>	Width	22¼"	Will Call	800	895	985	1080	1290	895	1035	1130	1290
		Depth	24½"	Zone 1	885	980	1070	1165	1375	980	1120	1215	1375
		Height	33"	Zone 2	895	990	1080	1175	1385	990	1130	1225	1385
		Seat Height	18¾"	Zone 3	900	995	1085	1180	1390	995	1135	1230	1390
		Seat Depth	19"	Zone 4	910	1005	1095	1190	1400	1005	1145	1240	1400
		Arm Height	27½"	Product Notes:									
		Width/B Arms	19"	Available without inside/outside back bottom detail, please specify (-NB).									
		COM	2¼ yds.	Available in all Taylor finishes.									
		COL	31 sq. ft.										
		Weight	34 lbs.										

¾ Back

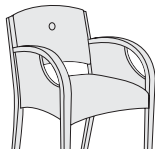
Model	Dimensions	Zone	COM	A	B	C	D	COL	L1	L2	L3		
9912PA Crescent	 <p>5 15</p>	Width	22¼"	Will Call	905	1000	1090	1185	1475	1000	1140	1230	1475
		Depth	24½"	Zone 1	990	1085	1175	1270	1560	1085	1225	1315	1560
		Height	33"	Zone 2	1000	1095	1185	1280	1570	1095	1235	1325	1570
		Seat Height	18¾"	Zone 3	1005	1100	1190	1285	1575	1100	1240	1330	1575
		Seat Depth	19"	Zone 4	1015	1110	1200	1295	1585	1110	1250	1340	1585
		Arm Height	27½"	Product Notes:									
		Width/B Arms	19"	Available without inside/outside back bottom detail, please specify (-NB).									
		COM	3¼ yds.	Available in all Taylor finishes.									
		COL	44 sq. ft.										
		Weight	37 lbs.										

¾ Back,
Panel Arm

Model	Dimensions	Zone	COM	A	B	C	D	COL	L1	L2	L3		
9913 Crescent	 <p>5 15</p>	Width	22¼"	Will Call	845	950	1045	1140	1365	950	1090	1185	1365
		Depth	24½"	Zone 1	930	1035	1130	1225	1450	1035	1175	1270	1450
		Height	33"	Zone 2	940	1045	1140	1235	1460	1045	1185	1280	1460
		Seat Height	18¾"	Zone 3	945	1050	1145	1240	1465	1050	1190	1285	1465
		Seat Depth	18¾"	Zone 4	955	1060	1155	1250	1475	1060	1200	1295	1475
		Arm Height	27½"	Product Notes:									
		Width/B Arms	19"	Available without outside back bottom detail, please specify (-NB).									
		COM	2½ yds.	Available in all Taylor finishes.									
		COL	34 sq. ft.										
		Weight	35 lbs.										

Closed Back

To specify, include:

- Model Number
- Wood Finish
- Fabric | Leather
- Quantity

- Wood Finishes**
- RCL Royal Cherry
 - LWL Light Walnut
 - ESP Espresso
 - MHL Mahogany
 - SMK Smoke
 - CML Clear Maple
 - COL Clear Oak
 - CHY Cherry
 - AMB Amber
 - BLK Black

Graded-In Fabric | Leather
 Specific grades for fabrics and leathers can be found on the separate grade cards found in your Taylor binder. For fabric and leather patterns not graded-in, please contact Customer Service for pricing.

Dimensions
 Dimensions listed in this price book are in inches and approximate.



Freight
 Zone list pricing includes freight prepaid by Taylor for delivery to one destination only within the zone. See pg. 5 for details.

Large Order Freight Discount
 For orders with 20 units or more, please contact Customer Service for pricing.

Minimum Prepaid Freight Charges
 Orders with 4 or less guest chairs will be charged **\$95 list per order**.

5 | 15

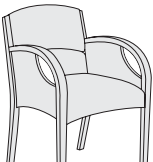
Five Rooms in Fifteen Days
 Seating marked with this logo is a part of Taylor's "Five Rooms in Fifteen Days" program. Refer to page 11 for details.

Model	Dimensions	Zone	COM	A	B	C	D	COL	L1	L2	L3
9913PA Crescent 	 Width 22¼" Depth 24½" Height 33" Seat Height 18¾" Seat Depth 18¼" Arm Height 27½" Width/B Arms 19" COM 3½ yds. COL 47 sq. ft. Weight 38 lbs.	Will Call	950	1055	1150	1240	1555	1055	1195	1290	1555
		Zone 1	1035	1140	1235	1325	1640	1140	1280	1375	1640
		Zone 2	1045	1150	1245	1335	1650	1150	1290	1385	1650
		Zone 3	1050	1155	1250	1340	1655	1155	1295	1390	1655
		Zone 4	1060	1165	1260	1350	1665	1165	1305	1400	1665

Product Notes:
 Available without outside back bottom detail, please specify (-NB).
 Available in all Taylor finishes.

Closed Back,
 Panel Arm

To specify, include:

- Model Number
- Wood Finish
- Fabric | Leather
- Quantity

Wood Finishes

- RCL Royal Cherry
- LWL Light Walnut
- ESP Espresso
- MHL Mahogany
- SMK Smoke
- CML Clear Maple
- COL Clear Oak
- CHY Cherry
- AMB Amber
- BLK Black

Graded-In Fabric | Leather

Specific grades for fabrics and leathers can be found on the separate grade cards found in your Taylor binder. For fabric and leather patterns not graded-in, please contact Customer Service for pricing.

Dimensions

Dimensions listed in this price book are in inches and approximate.

Freight

Zone list pricing includes freight prepaid by Taylor for delivery to one destination only within the zone. See pg. 5 for details.

Large Order Freight Discount

For orders with 20 units or more, please contact Customer Service for pricing.

Minimum Prepaid Freight Charges

Orders with 5 or less chairs (in any combination of guest, swivel, lounge, etc.) will be charged \$195 list per order.

5 | 15

Five Rooms in Fifteen Days

Seating marked with this logo is a part of Taylor's "Five Rooms in Fifteen Days" program. Refer to page 11 for details.

Model	Dimensions	Zone	COM	A	B	C	D	COL	L1	L2	L3		
2110.5 Zoe	 <p>Width 26¾" Depth 27" Height 36½" - 41" Seat Height 18½" - 23" Seat Depth 19½" Arm Height 26" - 30½" Width/B Arms 20¾" Standard Base 1805 Alternate Base 1705 COM 2¾ yds. COL 34 sq. ft. Weight 64 lbs.</p> <p>Two-Tone COM/COL* COM (Outside Back) 1 yd. COM (Inside Back/Seat) 2 yds. COL (Outside Back) 14 sq. ft. COL (Inside Back/Seat) 28 sq. ft.</p>	Will Call	1365	1505	1735	1945	2375	1505	1885	2090	2375		
		Zone 1	1495	1635	1865	2075	2505	1635	2015	2220	2505		
		Zone 2	1515	1655	1885	2095	2525	1655	2035	2240	2525		
		Zone 3	1520	1660	1890	2100	2530	1660	2040	2245	2530		
		Zone 4	1530	1670	1900	2110	2540	1670	2050	2255	2540		
		Product Notes: Synchro-tilt mechanism allows seat and back to tilt in a 2:1 ratio. Pneumatic height adjustment. Optional loop arm - reduce \$40 list , please specify. Alternate black, polyurethane base - reduce \$95 list , please specify (-1705 base).											
		*Two-tone upholstery applications will be priced at the higher of the two price grades. If two fabrics from the same price grade are used, item will be priced at the next higher price grade. If two COMs are used, item will be priced at the COL price grade.											
		Mid Back, Synchro-Tilt, Black/Metal Arm, Metal Base											

Model	Dimensions	Zone	COM	A	B	C	D	COL	L1	L2	L3		
2115.5 Zoe	 <p>Width 25¾" Depth 27" Height 36½" - 41" Seat Height 18½" - 23" Seat Depth 19½" Arm Height 26½" - 31" Width/B Arms 20¾" Standard Base 1705 Alternate Base 1805 COM 2¾ yds. COL 34 sq. ft. Weight 61 lbs.</p> <p>Two-Tone COM/COL* COM (Outside Back) 1 yd. COM (Inside Back/Seat) 2 yds. COL (Outside Back) 14 sq. ft. COL (Inside Back/Seat) 28 sq. ft.</p>	Will Call	1160	1400	1555	1745	2170	1400	1680	1880	2170		
		Zone 1	1290	1530	1685	1875	2300	1530	1810	2010	2300		
		Zone 2	1310	1550	1705	1895	2320	1550	1830	2030	2320		
		Zone 3	1315	1555	1710	1900	2325	1555	1835	2035	2325		
		Zone 4	1325	1565	1720	1910	2335	1565	1845	2045	2335		
		Product Notes: Swivel-tilt mechanism. Pneumatic height adjustment. Optional black/metal arm - add \$40 list , please specify. Alternate polished aluminum base - add \$95 list , please specify (-1805 base).											
		*Two-tone upholstery applications will be priced at the higher of the two price grades. If two fabrics from the same price grade are used, item will be priced at the next higher price grade. If two COMs are used, item will be priced at the COL price grade.											
		Mid Back, Swivel-Tilt, Loop Arm, Black Base											

Model	Dimensions	Zone	COM	A	B	C	D	COL	L1	L2	L3		
2120.5 Zoe	 <p>Width 28¾" Depth 27½" Height 43¼" - 47¾" Seat Height 18½" - 23" Seat Depth 19½" Arm Height 26" - 30½" Width/B Arms 22¾" Standard Base 1805 Alternate Base 1705 COM 3 yds. COL 41 sq. ft. Weight 67 lbs.</p> <p>Two-Tone COM/COL* COM (Outside Back) 1 yd. COM (Inside Back/Seat) 2¼ yds. COL (Outside Back) 14 sq. ft. COL (Inside Back/Seat) 31 sq. ft.</p>	Will Call	1470	1610	1840	2050	2510	1610	1990	2195	2510		
		Zone 1	1600	1740	1970	2180	2640	1740	2120	2325	2640		
		Zone 2	1620	1760	1990	2200	2660	1760	2140	2345	2660		
		Zone 3	1625	1765	1995	2205	2665	1765	2145	2350	2665		
		Zone 4	1635	1775	2005	2215	2675	1775	2155	2360	2675		
		Product Notes: Synchro-tilt mechanism allows seat and back to tilt in a 2:1 ratio. Pneumatic height adjustment. Optional loop arm - reduce \$40 list , please specify. Alternate black, polyurethane base - reduce \$95 list , please specify (-1705 base).											
		*Two-tone upholstery applications will be priced at the higher of the two price grades. If two fabrics from the same price grade are used, item will be priced at the next higher price grade. If two COMs are used, item will be priced at the COL price grade.											
		High Back, Synchro-Tilt, Black/Metal Arm, Metal Base											

To specify, include:

- Model Number
- Wood Finish
- Fabric | Leather
- Quantity

Wood Finishes

- RCL Royal Cherry
- LWL Light Walnut
- ESP Espresso
- MHL Mahogany
- SMK Smoke
- CML Clear Maple
- COL Clear Oak
- CHY Cherry
- AMB Amber
- BLK Black

Graded-In Fabric | Leather

Specific grades for fabrics and leathers can be found on the separate grade cards found in your Taylor binder. For fabric and leather patterns not graded-in, please contact Customer Service for pricing.

Dimensions

Dimensions listed in this price book are in inches and approximate.

Freight

Zone list pricing includes freight prepaid by Taylor for delivery to one destination only within the zone. See pg. 5 for details.

Large Order Freight Discount

For orders with 20 units or more, please contact Customer Service for pricing.

Minimum Prepaid Freight Charges

Orders with 5 or less chairs (in any combination of guest, swivel, lounge, etc.) will be charged \$195 list per order.

5|15

Five Rooms in Fifteen Days

Seating marked with this logo is a part of Taylor's "Five Rooms in Fifteen Days" program. Refer to page 11 for details.

Model	Dimensions	Zone	COM	A	B	C	D	COL	L1	L2	L3		
2125.5 Zoe  High Back, Swivel-Tilt, Loop Arm, Black Base	5 15 Width 27¾" Depth 27½" Height 43¼" - 47¾" Seat Height 18½" - 23" Seat Depth 19½" Arm Height 26½" - 31" Width/B Arms 22¾" Standard Base 1705 Alternate Base 1805 COM 3 yds. COL 41 sq. ft. Weight 64 lbs.	Will Call	1265	1500	1660	1850	2305	1500	1785	1985	2305		
		Zone 1	1395	1630	1790	1980	2435	1630	1915	2115	2435		
		Zone 2	1415	1650	1810	2000	2455	1650	1935	2135	2455		
		Zone 3	1420	1655	1815	2005	2460	1655	1940	2140	2460		
		Zone 4	1430	1665	1825	2015	2470	1665	1950	2150	2470		
		Product Notes: Swivel-tilt mechanism. Pneumatic height adjustment. Optional black/metal arm - add \$40 list , please specify. Alternate polished aluminum base - add \$95 list , please specify (-1805 base).											
		*Two-tone upholstery applications will be priced at the higher of the two price grades. If two fabrics from the same price grade are used, item will be priced at the next higher price grade. If two COMs are used, item will be priced at the COL price grade.											
		Two-Tone COM/COL* COM (Outside Back) 1 yd. COM (Inside Back/Seat) 2¼ yds. COL (Outside Back) 14 sq. ft. COL (Inside Back/Seat) 31 sq. ft.											

Model	Dimensions	Zone	COM	A	B	C	D	COL	L1	L2	L3		
2510.5 Parker  Mid Back, Open Arms	5 15 Width 26½" Depth 27½" Height 41" - 45" Seat Height 19" - 23" Seat Depth 18" Arm Height 27¼" - 31¼" Width/B Arms 19½" Standard Base 1905 Alternate Base 1205, 1705, 1805 COM 3½ yds. COL 44 sq. ft. Weight 66 lbs.	Will Call	1715	1915	2115	2315	2715	1915	2215	2415	2715		
		Zone 1	1845	2045	2245	2445	2845	2045	2345	2545	2845		
		Zone 2	1865	2065	2265	2465	2865	2065	2365	2565	2865		
		Zone 3	1870	2070	2270	2470	2870	2070	2370	2570	2870		
		Zone 4	1880	2080	2280	2480	2880	2080	2380	2580	2880		
		Product Notes: Synchro-tilt mechanism allows seat and back to tilt in a 2:1 ratio. Pneumatic height adjustment. Optional swivel-tilt mechanism - reduce \$25 list , please specify. Alternate black polyurethane base - reduce \$50 list , please specify (-1705 base). Wood bases (1205 & 1905) and wood arm post available in all Taylor finishes.											

Model	Dimensions	Zone	COM	A	B	C	D	COL	L1	L2	L3		
2510.5BA Parker  Mid Back, Black Polyurethane Arms	5 15 Width 26½" Depth 27½" Height 41" - 45" Seat Height 19" - 23" Seat Depth 18" Arm Height 27¼" - 31¼" Width/B Arms 21½" Standard Base 1705 Alternate Base 1205, 1805, 1905 COM 3½ yds. COL 41 sq. ft. Weight 63 lbs.	Will Call	1215	1470	1630	1795	2170	1470	1715	1915	2170		
		Zone 1	1345	1600	1760	1925	2300	1600	1845	2045	2300		
		Zone 2	1365	1620	1780	1945	2320	1620	1865	2065	2320		
		Zone 3	1370	1625	1785	1950	2325	1625	1870	2070	2325		
		Zone 4	1380	1635	1795	1960	2335	1635	1880	2080	2335		
		Product Notes: Synchro-tilt mechanism allows seat and back to tilt in a 2:1 ratio. Pneumatic height adjustment. Optional swivel-tilt mechanism - reduce \$25 list , please specify. Alternate polished aluminum base - add \$95 list , please specify (-1805 base). Alternate wood base - add \$95 list , please specify (-1905 base). Alternate wood bases (1205 & 1905) available in all Taylor finishes.											

To specify, include:

- Model Number
- Wood Finish
- Fabric | Leather
- Quantity

Wood Finishes

- RCL Royal Cherry
- LWL Light Walnut
- ESP Espresso
- MHL Mahogany
- SMK Smoke
- COL Clear Maple
- CML Clear Oak
- CHY Cherry
- AMB Amber
- BLK Black

Graded-In Fabric | Leather

Specific grades for fabrics and leathers can be found on the separate grade cards found in your Taylor binder. For fabric and leather patterns not graded-in, please contact Customer Service for pricing.

Dimensions

Dimensions listed in this price book are in inches and approximate.

Freight

Zone list pricing includes freight prepaid by Taylor for delivery to one destination only within the zone. See pg. 5 for details.

Large Order Freight Discount

For orders with 20 units or more, please contact Customer Service for pricing.

Minimum Prepaid Freight Charges

Orders with **5 or less chairs** (in any combination of guest, swivel, lounge, etc.) will be charged **\$195 list per order**.

5 | 15

Five Rooms in Fifteen Days

Seating marked with this logo is a part of Taylor's "Five Rooms in Fifteen Days" program. Refer to page 11 for details.

Model	Dimensions	Zone	COM	A	B	C	D	COL	L1	L2	L3	
2510.5CA Parker	Width	26½"	Will Call	1870	2070	2270	2470	2915	2070	2370	2570	2915
	Depth	27½"	Zone 1	2000	2200	2400	2600	3045	2200	2500	2700	3045
	Height	41" - 45"	Zone 2	2020	2220	2420	2620	3065	2220	2520	2720	3065
	Seat Height	19" - 23"	Zone 3	2025	2225	2425	2625	3070	2225	2525	2725	3070
	Seat Depth	18"	Zone 4	2035	2235	2435	2635	3080	2235	2535	2735	3080
	Arm Height	27" - 31"										
	Width/B Arms	19½"										
	Standard Base	1905										
	Alternate Base	1205, 1705, 1805										
	COM	3¾ yds.										
COL	51 sq. ft.											
Weight	68 lbs.											

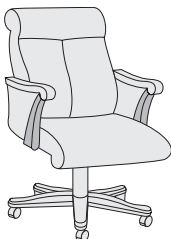

Mid Back, Closed Arms

Product Notes:

Synchro-tilt mechanism allows seat and back to tilt in a 2:1 ratio. Pneumatic height adjustment. Optional swivel-tilt mechanism - **reduce \$25 list**, please specify. Alternate black polyurethane base - **reduce \$50 list**, please specify (-1705 base). Wood bases (1205 & 1905) and wood arm post available in all Taylor finishes.

Model	Dimensions	Zone	COM	A	B	C	D	COL	L1	L2	L3	
2511.5 Parker	Width	21½"	Will Call	1115	1370	1530	1695	2070	1370	1615	1815	2070
	Depth	27½"	Zone 1	1245	1500	1660	1825	2200	1500	1745	1945	2200
	Height	41" - 45"	Zone 2	1265	1520	1680	1845	2220	1520	1765	1965	2220
	Seat Height	19" - 23"	Zone 3	1270	1525	1685	1850	2225	1525	1770	1970	2225
	Seat Depth	18"	Zone 4	1280	1535	1695	1860	2235	1535	1780	1980	2235
	Standard Base	1705										
	Alternate Base	1205, 1805, 1905										
	COM	3½ yds.										
	COL	41 sq. ft.										
	Weight	56 lbs.										



Mid Back, Armless

Product Notes:

Synchro-tilt mechanism allows seat and back to tilt in a 2:1 ratio. Pneumatic height adjustment. Optional swivel-tilt mechanism - **reduce \$25 list**, please specify. Alternate polished aluminum base - **add \$95 list**, please specify (-1805 base). Alternate wood base - **add \$95 list**, please specify (-1905 base). Alternate wood bases (1205 & 1905) available in all Taylor finishes.

Model	Dimensions	Zone	COM	A	B	C	D	COL	L1	L2	L3	
2520.5 Parker	Width	26½"	Will Call	1815	2015	2215	2415	2815	2015	2315	2515	2815
	Depth	29½"	Zone 1	1945	2145	2345	2545	2945	2145	2445	2645	2945
	Height	43" - 47"	Zone 2	1965	2165	2365	2565	2965	2165	2465	2665	2965
	Seat Height	19" - 23"	Zone 3	1970	2170	2370	2570	2970	2170	2470	2670	2970
	Seat Depth	18"	Zone 4	1980	2180	2380	2580	2980	2180	2480	2680	2980
	Arm Height	27¼" - 31¼"										
	Width/B Arms	19½"										
	Standard Base	1905										
	Alternate Base	1205, 1705, 1805										
	COM	3¾ yds.										
COL	47 sq. ft.											
Weight	69 lbs.											



High Back, Open Arms

Product Notes:

Synchro-tilt mechanism allows seat and back to tilt in a 2:1 ratio. Pneumatic height adjustment. Optional swivel-tilt mechanism - **reduce \$25 list**, please specify. Alternate black polyurethane base - **reduce \$50 list**, please specify (-1705 base). Wood bases (1205 & 1905) and wood arm post available in all Taylor finishes.

To specify, include:

- Model Number
- Wood Finish
- Fabric | Leather
- Quantity

Wood Finishes

- RCL Royal Cherry
- LWL Light Walnut
- ESP Espresso
- MHL Mahogany
- SMK Smoke
- CML Clear Maple
- COL Clear Oak
- CHY Cherry
- AMB Amber
- BLK Black

Graded-In Fabric | Leather

Specific grades for fabrics and leathers can be found on the separate grade cards found in your Taylor binder. For fabric and leather patterns not graded-in, please contact Customer Service for pricing.

Dimensions

Dimensions listed in this price book are in inches and approximate.

Freight

Zone list pricing includes freight prepaid by Taylor for delivery to one destination only within the zone. See pg. 5 for details.

Large Order Freight Discount

For orders with 20 units or more, please contact Customer Service for pricing.

Minimum Prepaid Freight Charges

Orders with 5 or less chairs (in any combination of guest, swivel, lounge, etc.) will be charged \$195 list per order.

5 | 15

Five Rooms in Fifteen Days

Seating marked with this logo is a part of Taylor's "Five Rooms in Fifteen Days" program. Refer to page 11 for details.

Model	Dimensions	Zone	COM	A	B	C	D	COL	L1	L2	L3		
2520.5BA Parker 	<div style="border: 1px solid black; padding: 2px; display: inline-block;">5 15</div> Width 26½" Depth 29½" Height 43" - 47" Seat Height 19" - 23" Seat Depth 18" Arm Height 27¼" - 31¼" Width/B Arms 21½" Standard Base 1705 Alternate Base 1205, 1805, 1905 COM 3¾ yds. COL 44 sq. ft. Weight 66 lbs.	Will Call	1315	1570	1730	1895	2270	1570	1815	2015	2270		
		Zone 1	1445	1700	1860	2025	2400	1700	1945	2145	2400		
		Zone 2	1465	1720	1880	2045	2420	1720	1965	2165	2420		
		Zone 3	1470	1725	1885	2050	2425	1725	1970	2170	2425		
		Zone 4	1480	1735	1895	2060	2435	1735	1980	2180	2435		
		Product Notes:											
		Synchro-tilt mechanism allows seat and back to tilt in a 2:1 ratio.											
		Pneumatic height adjustment.											
		Optional swivel-tilt mechanism - reduce \$25 list , please specify.											
		Alternate polished aluminum base - add \$95 list , please specify (-1805 base).											
Alternate wood base - add \$95 list , please specify (-1905 base).													
Alternate wood bases (1205 & 1905) available in all Taylor finishes.													

High Back, Black Polyurethane Arms

2520.5CA Parker 	Width 26½" Depth 29½" Height 43" - 47" Seat Height 19" - 23" Seat Depth 18" Arm Height 27" - 31" Width/B Arms 19½" Standard Base 1905 Alternate Base 1205, 1705, 1805 COM 4 yds. COL 54 sq. ft. Weight 71 lbs.	Will Call	1970	2170	2370	2570	3015	2170	2470	2670	3015		
		Zone 1	2100	2300	2500	2700	3145	2300	2600	2800	3145		
		Zone 2	2120	2320	2520	2720	3165	2320	2620	2820	3165		
		Zone 3	2125	2325	2525	2725	3170	2325	2625	2825	3170		
		Zone 4	2135	2335	2535	2735	3180	2335	2635	2835	3180		
		Product Notes:											
		Synchro-tilt mechanism allows seat and back to tilt in a 2:1 ratio.											
		Pneumatic height adjustment.											
		Optional swivel-tilt mechanism - reduce \$25 list , please specify.											
		Alternate black polyurethane base - reduce \$50 list , please specify (-1705 base).											
Wood bases (1205 & 1905) and wood arm post available in all Taylor finishes.													

High Back, Closed Arms

2521.5 Parker 	Width 21½" Depth 29½" Height 43" - 47" Seat Height 19" - 23" Seat Depth 18" Standard Base 1705 Alternate Base 1205, 1805, 1905 COM 3¾ yds. COL 44 sq. ft. Weight 59 lbs.	Will Call	1215	1470	1630	1795	2170	1470	1715	1915	2170		
		Zone 1	1345	1600	1760	1925	2300	1600	1845	2045	2300		
		Zone 2	1365	1620	1780	1945	2320	1620	1865	2065	2320		
		Zone 3	1370	1625	1785	1950	2325	1625	1870	2070	2325		
		Zone 4	1380	1635	1795	1960	2335	1635	1880	2080	2335		
		Product Notes:											
		Synchro-tilt mechanism allows seat and back to tilt in a 2:1 ratio.											
		Pneumatic height adjustment.											
		Optional swivel-tilt mechanism - reduce \$25 list , please specify.											
		Alternate polished aluminum base - add \$95 list , please specify (-1805 base).											
Alternate wood base - add \$95 list , please specify (-1905 base).													
Alternate wood bases (1205 & 1905) available in all Taylor finishes.													

High Back, Armless

To specify, include:

- Model Number
- Wood Finish
- Fabric | Leather
- Quantity

Wood Finishes

- RCL Royal Cherry
- LWL Light Walnut
- ESP Espresso
- MHL Mahogany
- SMK Smoke
- CML Clear Maple
- COL Clear Oak
- CHY Cherry
- AMB Amber
- BLK Black

Graded-In Fabric | Leather

Specific grades for fabrics and leathers can be found on the separate grade cards found in your Taylor binder. For fabric and leather patterns not graded-in, please contact Customer Service for pricing.

Dimensions

Dimensions listed in this price book are in inches and approximate.

Freight

Zone list pricing includes freight prepaid by Taylor for delivery to one destination only within the zone. See pg. 5 for details.

Large Order Freight Discount

For orders with 20 units or more, please contact Customer Service for pricing.

Minimum Prepaid Freight Charges

Orders with **5 or less chairs** (in any combination of guest, swivel, lounge, etc.) will be charged **\$195 list per order**.

5 | 15

Five Rooms in Fifteen Days

Seating marked with this logo is a part of Taylor's "Five Rooms in Fifteen Days" program. Refer to page 11 for details.

Model	Dimensions	Zone	COM	A	B	C	D	COL	L1	L2	L3	
7612.5 Classic	Width	23¼"	Will Call	895	975	1040	1100	1475	975	1075	1175	1475
	Depth	25"	Zone 1	1025	1105	1170	1230	1605	1105	1205	1305	1605
	Height	30¾" - 34½"	Zone 2	1045	1125	1190	1250	1625	1125	1225	1325	1625
	Seat Height	17½" - 21¼"	Zone 3	1050	1130	1195	1255	1630	1130	1230	1330	1630
	Seat Depth	19¾"	Zone 4	1060	1140	1205	1265	1640	1140	1240	1340	1640
	Arm Height	22½" - 26¼"										
	Width/B Arms	19"										
	Standard Base	405										
	COM	3 yds.										
	COL	41 sq. ft.										
	Weight	60 lbs.										



Steam Bent Top Rail

Product Notes:

Pneumatic height adjustment and swivel-tilt mechanism. Available in all Taylor finishes.

Model	Dimensions	Zone	COM	A	B	C	D	COL	L1	L2	L3	
8114.5 Classic	Width	24¼"	Will Call	1265	1425	1520	1640	2095	1425	1570	1760	2095
	Depth	24"	Zone 1	1395	1555	1650	1770	2225	1555	1700	1890	2225
	Height	29" - 32¾"	Zone 2	1415	1575	1670	1790	2245	1575	1720	1910	2245
	Seat Height	16¾" - ?	Zone 3	1420	1580	1675	1795	2250	1580	1725	1915	2250
	Seat Depth	19"	Zone 4	1430	1590	1685	1805	2260	1590	1735	1925	2260
	Arm Height	23¼" - 27"										
	Width/B Arms	19"										
	Standard Base	405										
	COM	2¾ yds.										
	COL	38 sq. ft.										
	Weight	65 lbs.										



Steam Bent Top Rail

Product Notes:

Not available in vinyl upholstery. Mechanical height adjustment and swivel-tilt mechanism. Available in all Taylor finishes.

Model	Dimensions	Zone	COM	A	B	C	D	COL	L1	L2	L3	
8810.5BA Bentley	Width	25¼"	Will Call	1215	1390	1525	1680	2125	1390	1600	1805	2125
	Depth	27¾"	Zone 1	1345	1520	1655	1810	2255	1520	1730	1935	2255
	Height	35" - 38¾"	Zone 2	1365	1540	1675	1830	2275	1540	1750	1955	2275
	Seat Height	19½" - 23¼"	Zone 3	1370	1545	1680	1835	2280	1545	1755	1960	2280
	Seat Depth	19"	Zone 4	1380	1555	1690	1845	2290	1555	1765	1970	2290
	Arm Height	27" - 30¾"										
	Width/B Arms	20½"										
	Standard Base	1705										
	Alternate Base	1205, 1805										
	COM	2½ yds.										
	COL	34 sq. ft.										
	Weight	54 lbs.										

5 | 15



Low Back, Black Polyurethane Arms

Product Notes:

Pneumatic height adjustment and knee-tilt mechanism. Optional swivel-tilt mechanism - **reduce \$25 list**, please specify. Alternate polished aluminum base - **add \$95 list**, please specify (-1805 base). Alternate wood base (1205) available in all Taylor finishes.

To specify, include:

- Model Number
- Wood Finish
- Fabric | Leather
- Quantity

Wood Finishes

- RCL Royal Cherry
- LWL Light Walnut
- ESP Espresso
- MHL Mahogany
- SMK Smoke
- CML Clear Maple
- COL Clear Oak
- CHY Cherry
- AMB Amber
- BLK Black

Graded-In Fabric | Leather

Specific grades for fabrics and leathers can be found on the separate grade cards found in your Taylor binder. For fabric and leather patterns not graded-in, please contact Customer Service for pricing.

Dimensions

Dimensions listed in this price book are in inches and approximate.

Freight

Zone list pricing includes freight prepaid by Taylor for delivery to one destination only within the zone. See pg. 5 for details.

Large Order Freight Discount

For orders with 20 units or more, please contact Customer Service for pricing.

Minimum Prepaid Freight Charges

Orders with **5 or less chairs** (in any combination of guest, swivel, lounge, etc.) will be charged **\$195 list per order**.

5 | 15

Five Rooms in Fifteen Days

Seating marked with this logo is a part of Taylor's "Five Rooms in Fifteen Days" program. Refer to page 11 for details.

Model	Dimensions	Zone	COM	A	B	C	D	COL	L1	L2	L3		
8810.5UA Bentley	 <p>5 15</p> <p>Width 25" Depth 27¾" Height 35" - 38¾" Seat Height 19½" - 23¼" Seat Depth 19" Arm Height 27" - 30¾" Width/B Arms 20½" Standard Base 1705 Alternate Base 1205, 1805 COM 2¾ yds. COL 38 sq. ft. Weight 54 lbs.</p>	Will Call	1265	1435	1570	1725	2175	1435	1650	1850	2175		
		Zone 1	1395	1565	1700	1855	2305	1565	1780	1980	2305		
		Zone 2	1415	1585	1720	1875	2325	1585	1800	2000	2325		
		Zone 3	1420	1590	1725	1880	2330	1590	1805	2005	2330		
		Zone 4	1430	1600	1735	1890	2340	1600	1815	2015	2340		
		Product Notes:											
		Pneumatic height adjustment and knee-tilt mechanism.											
		Optional swivel-tilt mechanism - reduce \$25 list , please specify.											
		Alternate polished aluminum base - add \$95 list , please specify (-1805 base).											
		Alternate wood base (1205) available in all Taylor finishes.											

Low Back,
Upholstered Arms

Model	Dimensions	Zone	COM	A	B	C	D	COL	L1	L2	L3		
8810.5CA Bentley	 <p>5 15</p> <p>Width 25" Depth 27¾" Height 35" - 38¾" Seat Height 19½" - 23¼" Seat Depth 19" Arm Height 27" - 30¾" Width/B Arms 20¼" Standard Base 1705 Alternate Base 1205, 1805 COM 3 yds. COL 45 sq. ft. Weight 58 lbs.</p>	Will Call	1295	1465	1600	1755	2235	1465	1680	1880	2235		
		Zone 1	1425	1595	1730	1885	2365	1595	1810	2010	2365		
		Zone 2	1445	1615	1750	1905	2385	1615	1830	2030	2385		
		Zone 3	1450	1620	1755	1910	2390	1620	1835	2035	2390		
		Zone 4	1460	1630	1765	1920	2400	1630	1845	2045	2400		
		Product Notes:											
		Pneumatic height adjustment and knee-tilt mechanism.											
		Optional swivel-tilt mechanism - reduce \$25 list , please specify.											
		Alternate polished aluminum base - add \$95 list , please specify (-1805 base).											
		Alternate wood base (1205) available in all Taylor finishes.											

Low Back,
Closed Arms

Model	Dimensions	Zone	COM	A	B	C	D	COL	L1	L2	L3		
8811.5BA Bentley	 <p>5 15</p> <p>Width 25¼" Depth 29" Height 39" - 42¾" Seat Height 19½" - 23¼" Seat Depth 19" Arm Height 27" - 30¾" Width/B Arms 20½" Standard Base 1705 Alternate Base 1205, 1805 COM 2¾ yds. COL 38 sq. ft. Weight 56 lbs.</p>	Will Call	1300	1470	1605	1760	2240	1470	1685	1890	2240		
		Zone 1	1430	1600	1735	1890	2370	1600	1815	2020	2370		
		Zone 2	1450	1620	1755	1910	2390	1620	1835	2040	2390		
		Zone 3	1455	1625	1760	1915	2395	1625	1840	2045	2395		
		Zone 4	1465	1635	1770	1925	2405	1635	1850	2055	2405		
		Product Notes:											
		Pneumatic height adjustment and knee-tilt mechanism.											
		Optional swivel-tilt mechanism - reduce \$25 list , please specify.											
		Alternate polished aluminum base - add \$95 list , please specify (-1805 base).											
		Alternate wood base (1205) available in all Taylor finishes.											

High Back,
Black Polyurethane Arms

To specify, include:

- Model Number
- Wood Finish
- Fabric | Leather
- Quantity

Wood Finishes

- RCL Royal Cherry
- LWL Light Walnut
- ESP Espresso
- MHL Mahogany
- SMK Smoke
- CML Clear Maple
- COL Clear Oak
- CHY Cherry
- AMB Amber
- BLK Black

Graded-In Fabric | Leather

Specific grades for fabrics and leathers can be found on the separate grade cards found in your Taylor binder. For fabric and leather patterns not graded-in, please contact Customer Service for pricing.

Dimensions

Dimensions listed in this price book are in inches and approximate.

Freight

Zone list pricing includes freight prepaid by Taylor for delivery to one destination only within the zone. See pg. 5 for details.

Large Order Freight Discount

For orders with 20 units or more, please contact Customer Service for pricing.

Minimum Prepaid Freight Charges

Orders with 5 or less chairs (in any combination of guest, swivel, lounge, etc.) will be charged \$195 list per order.

5|15

Five Rooms in Fifteen Days

Seating marked with this logo is a part of Taylor's "Five Rooms in Fifteen Days" program. Refer to page 11 for details.

Model	Dimensions	Zone	COM	A	B	C	D	COL	L1	L2	L3	
8811.5UA Bentley	Width	25"	Will Call	1345	1520	1655	1810	2275	1520	1730	1940	2275
	Depth	29"	Zone 1	1475	1650	1785	1940	2405	1650	1860	2070	2405
	Height	39" - 42¾"	Zone 2	1495	1670	1805	1960	2425	1670	1880	2090	2425
	Seat Height	19½" - 23¼"	Zone 3	1500	1675	1810	1965	2430	1675	1885	2095	2430
	Seat Depth	19"	Zone 4	1510	1685	1820	1975	2440	1685	1895	2105	2440
	Arm Height	27" - 30¾"	Product Notes:									
	Width/B Arms	20½"	Pneumatic height adjustment and knee-tilt mechanism.									
	Standard Base	1705	Optional swivel-tilt mechanism - reduce \$25 list , please specify.									
	Alternate Base	1205, 1805	Alternate polished aluminum base - add \$95 list , please specify (-1805 base).									
	COM	3 yds.	Alternate wood base (1205) available in all Taylor finishes.									
COL	41 sq. ft.											
Weight	56 lbs.											



High Back,
Upholstered Arms

Model	Dimensions	Zone	COM	A	B	C	D	COL	L1	L2	L3	
8811.5CA Bentley	Width	25"	Will Call	1375	1550	1685	1840	2330	1550	1760	1970	2330
	Depth	29"	Zone 1	1505	1680	1815	1970	2460	1680	1890	2100	2460
	Height	39" - 42¾"	Zone 2	1525	1700	1835	1990	2480	1700	1910	2120	2480
	Seat Height	19½" - 23¼"	Zone 3	1530	1705	1840	1995	2485	1705	1915	2125	2485
	Seat Depth	19"	Zone 4	1540	1715	1850	2005	2495	1715	1925	2135	2495
	Arm Height	27" - 30¾"	Product Notes:									
	Width/B Arms	20½"	Pneumatic height adjustment and knee-tilt mechanism.									
	Standard Base	1705	Optional swivel-tilt mechanism - reduce \$25 list , please specify.									
	Alternate Base	1205, 1805	Alternate polished aluminum base - add \$95 list , please specify (-1805 base).									
	COM	3¼ yds.	Alternate wood base (1205) available in all Taylor finishes.									
COL	47 sq. ft.											
Weight	60 lbs.											



High Back,
Closed Arms

Model	Dimensions	Zone	COM	A	B	C	D	COL	L1	L2	L3	
9500.5 Aurora	Width	25½"	Will Call	1840	2050	2255	2465	3225	2050	2360	2645	3225
	Depth	28"	Zone 1	1970	2180	2385	2595	3355	2180	2490	2775	3355
	Height	38¼" - 42"	Zone 2	1990	2200	2405	2615	3375	2200	2510	2795	3375
	Seat Height	18½" - 22¼"	Zone 3	1995	2205	2410	2620	3380	2205	2515	2800	3380
	Seat Depth	18¼"	Zone 4	2005	2215	2420	2630	3390	2215	2525	2810	3390
	Arm Height	26¼" - 30"	Product Notes:									
	Width/B Arms	20¾"	Pneumatic height adjustment and knee-tilt mechanism.									
	Standard Base	1205	Optional swivel-tilt mechanism - reduce \$25 list , please specify.									
	Alternate Base	1705, 1805	Alternate polished aluminum base - add \$95 list , please specify (-1805 base).									
	COM	4¾ yds.	Wood base (1205) available in all Taylor finishes.									
COL	65 sq. ft.											
Weight	57 lbs.											



Mid Back,
Upholstered Arms

To specify, include:

- Model Number
- Wood Finish
- Fabric | Leather
- Quantity

Wood Finishes

- RCL Royal Cherry
- LWL Light Walnut
- ESP Espresso
- MHL Mahogany
- SMK Smoke
- CML Clear Maple
- COL Clear Oak
- CHY Cherry
- AMB Amber
- BLK Black

Graded-In Fabric | Leather

Specific grades for fabrics and leathers can be found on the separate grade cards found in your Taylor binder. For fabric and leather patterns not graded-in, please contact Customer Service for pricing.

Dimensions

Dimensions listed in this price book are in inches and approximate.

Freight

Zone list pricing includes freight prepaid by Taylor for delivery to one destination only within the zone. See pg. 5 for details.

Large Order Freight Discount

For orders with 20 units or more, please contact Customer Service for pricing.

Minimum Prepaid Freight Charges

Orders with **5 or less chairs** (in any combination of guest, swivel, lounge, etc.) will be charged **\$195 list per order**.

5 | 15

Five Rooms in Fifteen Days

Seating marked with this logo is a part of Taylor's "Five Rooms in Fifteen Days" program. Refer to page 11 for details.

Model	Dimensions	Zone	COM	A	B	C	D	COL	L1	L2	L3		
9500.5BA Aurora 	<div style="border: 1px solid black; padding: 2px; display: inline-block;">5 15</div> Width 25½" Depth 28" Height 38¼" - 42" Seat Height 18½" - 22¼" Seat Depth 18¼" Arm Height 26¼" - 30" Width/B Arms 20¾" Standard Base 1705 Alternate Base 1205, 1805 COM 4¾ yds. COL 65 sq. ft. Weight 54 lbs.	Will Call	1840	2050	2255	2465	3225	2050	2360	2645	3225		
		Zone 1	1970	2180	2385	2595	3355	2180	2490	2775	3355		
		Zone 2	1990	2200	2405	2615	3375	2200	2510	2795	3375		
		Zone 3	1995	2205	2410	2620	3380	2205	2515	2800	3380		
		Zone 4	2005	2215	2420	2630	3390	2215	2525	2810	3390		
		Product Notes:											
		Pneumatic height adjustment and knee-tilt mechanism.											
		Optional swivel-tilt mechanism - reduce \$25 list , please specify.											
		Alternate polished aluminum base - add \$95 list , please specify (-1805 base).											
		Alternate wood base (1205) available in all Taylor finishes.											

Mid Back,
Black Polyurethane Arms

9500.5CA Aurora 	<div style="border: 1px solid black; padding: 2px; display: inline-block;">5 15</div> Width 25½" Depth 28" Height 38¼" - 42" Seat Height 18½" - 22¼" Seat Depth 18¼" Arm Height 26¼" - 30" Width/B Arms 20¾" Standard Base 1205 Alternate Base 1705, 1805 COM 5½ yds. COL 75 sq. ft. Weight 61 lbs.	Zone	COM	A	B	C	D	COL	L1	L2	L3		
		Will Call	1945	2150	2360	2570	3350	2150	2465	2750	3350		
		Zone 1	2075	2280	2490	2700	3480	2280	2595	2880	3480		
		Zone 2	2095	2300	2510	2720	3500	2300	2615	2900	3500		
		Zone 3	2100	2305	2515	2725	3505	2305	2620	2905	3505		
		Zone 4	2110	2315	2525	2735	3515	2315	2630	2915	3515		
		Product Notes:											
		Pneumatic height adjustment and knee-tilt mechanism.											
		Optional swivel-tilt mechanism - reduce \$25 list , please specify.											
		Alternate polished aluminum base - add \$95 list , please specify (-1805 base).											
Wood base (1205) available in all Taylor finishes.													

Mid Back,
Closed Arms

9510.5 Aurora 	<div style="border: 1px solid black; padding: 2px; display: inline-block;">5 15</div> Width 25½" Depth 28" Height 34¼" - 38" Seat Height 18½" - 22¼" Seat Depth 18¼" Arm Height 26¼" - 30" Width/B Arms 20¾" Standard Base 1205 Alternate Base 1705, 1805 COM 4¾ yds. COL 65 sq. ft. Weight 55 lbs.	Zone	COM	A	B	C	D	COL	L1	L2	L3		
		Will Call	1785	1990	2200	2405	3210	1990	2305	2615	3210		
		Zone 1	1915	2120	2330	2535	3340	2120	2435	2745	3340		
		Zone 2	1935	2140	2350	2555	3360	2140	2455	2765	3360		
		Zone 3	1940	2145	2355	2560	3365	2145	2460	2770	3365		
		Zone 4	1950	2155	2365	2570	3375	2155	2470	2780	3375		
		Product Notes:											
		Pneumatic height adjustment and knee-tilt mechanism.											
		Optional swivel-tilt mechanism - reduce \$25 list , please specify.											
		Alternate polished aluminum base - add \$95 list , please specify (-1805 base).											
Wood base (1205) available in all Taylor finishes.													

Low Back,
Upholstered Arms

To specify, include:

- Model Number
- Wood Finish
- Fabric | Leather
- Quantity

Wood Finishes

- RCL Royal Cherry
- LWL Light Walnut
- ESP Espresso
- MHL Mahogany
- SMK Smoke
- CML Clear Maple
- COL Clear Oak
- CHY Cherry
- AMB Amber
- BLK Black

Graded-In Fabric | Leather

Specific grades for fabrics and leathers can be found on the separate grade cards found in your Taylor binder. For fabric and leather patterns not graded-in, please contact Customer Service for pricing.

Dimensions

Dimensions listed in this price book are in inches and approximate.

Freight

Zone list pricing includes freight prepaid by Taylor for delivery to one destination only within the zone. See pg. 5 for details.

Large Order Freight Discount

For orders with 20 units or more, please contact Customer Service for pricing.

Minimum Prepaid Freight Charges

Orders with 5 or less chairs (in any combination of guest, swivel, lounge, etc.) will be charged \$195 list per order.

5 | 15

Five Rooms in Fifteen Days

Seating marked with this logo is a part of Taylor's "Five Rooms in Fifteen Days" program. Refer to page 11 for details.

Model	Dimensions	Zone	COM	A	B	C	D	COL	L1	L2	L3		
9510.5BA Aurora 	<div style="background-color: #ccc; padding: 5px; display: inline-block;">5 15</div>	Width	25½"	Will Call	1785	1990	2200	2405	3210	1990	2305	2615	3210
		Depth	28"	Zone 1	1915	2120	2330	2535	3340	2120	2435	2745	3340
		Height	34¼" - 38"	Zone 2	1935	2140	2350	2555	3360	2140	2455	2765	3360
		Seat Height	18½" - 22¼"	Zone 3	1940	2145	2355	2560	3365	2145	2460	2770	3365
		Seat Depth	18¼"	Zone 4	1950	2155	2365	2570	3375	2155	2470	2780	3375
		Arm Height	26¼" - 30"	Product Notes:									
		Width/B Arms	20¾"	Pneumatic height adjustment and knee-tilt mechanism.									
		Standard Base	1705	Optional swivel-tilt mechanism - reduce \$25 list , please specify.									
		Alternate Base	1205, 1805	Alternate polished aluminum base - add \$95 list , please specify (-1805 base).									
		COM	4¾ yds.	Alternate wood base (1205) available in all Taylor finishes.									
COL	65 sq. ft.												
Weight	52 lbs.												
<p>Low Back, Black Polyurethane Arms</p>													

9510.5CA Aurora 	<div style="background-color: #ccc; padding: 5px; display: inline-block;">5 15</div>	Width	25½"	Zone	COM	A	B	C	D	COL	L1	L2	L3
		Depth	28"	Will Call	1885	2095	2305	2510	3345	2095	2405	2720	3345
		Height	34¼" - 38"	Zone 1	2015	2225	2435	2640	3475	2225	2535	2850	3475
		Seat Height	18½" - 22¼"	Zone 2	2035	2245	2455	2660	3495	2245	2555	2870	3495
		Seat Depth	18¼"	Zone 3	2040	2250	2460	2665	3500	2250	2560	2875	3500
		Arm Height	26¼" - 30"	Zone 4	2050	2260	2470	2675	3510	2260	2570	2885	3510
		Width/B Arms	20¾"	Product Notes:									
		Standard Base	1205	Pneumatic height adjustment and knee-tilt mechanism.									
		Alternate Base	1705, 1805	Optional swivel-tilt mechanism - reduce \$25 list , please specify.									
		COM	5 yds.	Alternate polished aluminum base - add \$95 list , please specify (-1805 base).									
COL	68 sq. ft.	Wood base (1205) available in all Taylor finishes.											
Weight	59 lbs.												
<p>Low Back, Closed Arms</p>													

9520.5 Aurora 	<div style="background-color: #ccc; padding: 5px; display: inline-block;">5 15</div>	Width	27"	Zone	COM	A	B	C	D	COL	L1	L2	L3
		Depth	30"	Will Call	2010	2215	2410	2645	3480	2215	2510	2830	3480
		Height	43¾" - 47½"	Zone 1	2140	2345	2540	2775	3610	2345	2640	2960	3610
		Seat Height	19¼" - 23"	Zone 2	2160	2365	2560	2795	3630	2365	2660	2980	3630
		Seat Depth	19½"	Zone 3	2165	2370	2565	2800	3635	2370	2665	2985	3635
		Arm Height	26¼" - 30"	Zone 4	2175	2380	2575	2810	3645	2380	2675	2995	3645
		Width/B Arms	22¼"	Product Notes:									
		Standard Base	1205	Pneumatic height adjustment and knee-tilt mechanism.									
		Alternate Base	1705, 1805	Optional swivel-tilt mechanism - reduce \$25 list , please specify.									
		COM	5¾ yds.	Alternate polished aluminum base - add \$95 list , please specify (-1805 base).									
COL	77 sq. ft.	Wood base (1205) available in all Taylor finishes.											
Weight	64 lbs.												
<p>High Back, Upholstered Arms</p>													

To specify, include:

- Model Number
- Wood Finish
- Fabric | Leather
- Quantity

Wood Finishes

- RCL Royal Cherry
- LWL Light Walnut
- ESP Espresso
- MHL Mahogany
- SMK Smoke
- CML Clear Maple
- COL Clear Oak
- CHY Cherry
- AMB Amber
- BLK Black

Graded-In Fabric | Leather

Specific grades for fabrics and leathers can be found on the separate grade cards found in your Taylor binder. For fabric and leather patterns not graded-in, please contact Customer Service for pricing.

Dimensions

Dimensions listed in this price book are in inches and approximate.

Freight

Zone list pricing includes freight prepaid by Taylor for delivery to one destination only within the zone. See pg. 5 for details.

Large Order Freight Discount

For orders with 20 units or more, please contact Customer Service for pricing.

Minimum Prepaid Freight Charges

Orders with 5 or less chairs (in any combination of guest, swivel, lounge, etc.) will be charged \$195 list per order.

5 | 15

Five Rooms in Fifteen Days

Seating marked with this logo is a part of Taylor's "Five Rooms in Fifteen Days" program. Refer to page 11 for details.

Model	Dimensions	Zone	COM	A	B	C	D	COL	L1	L2	L3		
9520.5BA Aurora 	<div style="background-color: #e0e0e0; padding: 5px; display: inline-block;">5 15</div> Width 27" Depth 30" Height 43¾" - 47½" Seat Height 19¼" - 23" Seat Depth 19½" Arm Height 26¼" - 30" Width/B Arms 22¼" Standard Base 1705 Alternate Base 1205, 1805 COM 5¾ yds. COL 77 sq. ft. Weight 61 lbs.	Will Call	2010	2215	2410	2645	3480	2215	2510	2830	3480		
		Zone 1	2140	2345	2540	2775	3610	2345	2640	2960	3610		
		Zone 2	2160	2365	2560	2795	3630	2365	2660	2980	3630		
		Zone 3	2165	2370	2565	2800	3635	2370	2665	2985	3635		
		Zone 4	2175	2380	2575	2810	3645	2380	2675	2995	3645		
		Product Notes: Pneumatic height adjustment and knee-tilt mechanism. Optional swivel-tilt mechanism - reduce \$25 list , please specify. Alternate polished aluminum base - add \$95 list , please specify (-1805 base). Alternate wood base (1205) available in all Taylor finishes.											

High Back,
Black Polyurethane Arms

Model	Dimensions	Zone	COM	A	B	C	D	COL	L1	L2	L3		
9520.5CA Aurora 	<div style="background-color: #e0e0e0; padding: 5px; display: inline-block;">5 15</div> Width 27" Depth 30" Height 43¾" - 47½" Seat Height 19¼" - 23" Seat Depth 19½" Arm Height 26¼" - 30" Width/B Arms 22¼" Standard Base 1205 Alternate Base 1705, 1805 COM 6 yds. COL 81 sq. ft. Weight 67 lbs.	Will Call	2115	2320	2515	2750	3635	2320	2615	2930	3635		
		Zone 1	2245	2450	2645	2880	3765	2450	2745	3060	3765		
		Zone 2	2265	2470	2665	2900	3785	2470	2765	3080	3785		
		Zone 3	2270	2475	2670	2905	3790	2475	2770	3085	3790		
		Zone 4	2280	2485	2680	2915	3800	2485	2780	3095	3800		
		Product Notes: Pneumatic height adjustment and knee-tilt mechanism. Optional swivel-tilt mechanism - reduce \$25 list , please specify. Alternate polished aluminum base - add \$95 list , please specify (-1805 base). Wood base (1205) available in all Taylor finishes.											

High Back,
Closed Arms

Model	Dimensions	Zone	COM	A	B	C	D	COL	L1	L2	L3		
9710.5CL Ventura 	<div style="background-color: #e0e0e0; padding: 5px; display: inline-block;">5 15</div> Width 25½" Depth 27" Height 36" - 39¾" Seat Height 18½" - 22¼" Seat Depth 19" Arm Height 26" - 29¾" Width/B Arms 18¾" Standard Base 1205 Alternate Base 1705, 1805 COM 4 yds. COL 54 sq. ft. Weight 63 lbs.	Will Call	1365	1555	1735	1945	2605	1555	1840	2085	2605		
		Zone 1	1495	1685	1865	2075	2735	1685	1970	2215	2735		
		Zone 2	1515	1705	1885	2095	2755	1705	1990	2235	2755		
		Zone 3	1520	1710	1890	2100	2760	1710	1995	2240	2760		
		Zone 4	1530	1720	1900	2110	2770	1720	2005	2250	2770		
		Product Notes: Pneumatic height adjustment and knee-tilt mechanism. Optional swivel-tilt mechanism - reduce \$25 list , please specify. Adjustable lumbar support mechanism. Optional without lumbar support mechanism, please specify. Alternate polished aluminum base - add \$95 list , please specify (-1805 base). Wood base (1205) available in all Taylor finishes.											

Classic Style,
Low Back

To specify, include:

- Model Number
- Wood Finish
- Fabric | Leather
- Quantity

Wood Finishes

- RCL Royal Cherry
- LWL Light Walnut
- ESP Espresso
- MHL Mahogany
- SMK Smoke
- CML Clear Maple
- COL Clear Oak
- CHY Cherry
- AMB Amber
- BLK Black

Graded-In Fabric | Leather

Specific grades for fabrics and leathers can be found on the separate grade cards found in your Taylor binder. For fabric and leather patterns not graded-in, please contact Customer Service for pricing.

Dimensions

Dimensions listed in this price book are in inches and approximate.

Freight

Zone list pricing includes freight prepaid by Taylor for delivery to one destination only within the zone. See pg. 5 for details.

Large Order Freight Discount

For orders with 20 units or more, please contact Customer Service for pricing.

Minimum Prepaid Freight Charges

Orders with **5 or less chairs** (in any combination of guest, swivel, lounge, etc.) will be charged **\$195 list per order**.

5 | 15

Five Rooms in Fifteen Days

Seating marked with this logo is a part of Taylor's "Five Rooms in Fifteen Days" program. Refer to page 11 for details.

Model	Dimensions	Zone	COM	A	B	C	D	COL	L1	L2	L3		
9710.5CL-BA Ventura 	<div style="background-color: #ccc; padding: 5px; display: inline-block;">5 15</div> Width 24" Depth 27" Height 36" - 39 3/4" Seat Height 18 1/2" - 22 1/4" Seat Depth 19" Arm Height 26" - 29 3/4" Width/B Arms 18 3/4" Standard Base 1705 Alternate Base 1205, 1805 COM 4 yds. COL 54 sq. ft. Weight 60 lbs.	Will Call	1365	1555	1735	1945	2605	1555	1840	2085	2605		
		Zone 1	1495	1685	1865	2075	2735	1685	1970	2215	2735		
		Zone 2	1515	1705	1885	2095	2755	1705	1990	2235	2755		
		Zone 3	1520	1710	1890	2100	2760	1710	1995	2240	2760		
		Zone 4	1530	1720	1900	2110	2770	1720	2005	2250	2770		
		Product Notes:											
		Pneumatic height adjustment and knee-tilt mechanism.											
		Optional swivel-tilt mechanism - reduce \$25 list , please specify.											
		Adjustable lumbar support mechanism.											
		Optional without lumbar support mechanism, please specify.											
Alternate polished aluminum base - add \$95 list , please specify (-1805 base).													
Alternate wood base (1205) available in all Taylor finishes.													

Classic Style, Low Back, Black Polyurethane Arms

Model	Dimensions	Zone	COM	A	B	C	D	COL	L1	L2	L3		
9710.5PF Ventura 	<div style="background-color: #ccc; padding: 5px; display: inline-block;">5 15</div> Width 24" Depth 27" Height 35 1/2" - 39 3/4" Seat Height 18 1/2" - 22 1/4" Seat Depth 18 3/4" Arm Height 25 3/4" - 29 1/2" Width/B Arms 19" Standard Base 1205 Alternate Base 1705, 1805 COM 3 1/4 yds. COL 44 sq. ft. Weight 63 lbs.	Will Call	1160	1415	1590	1805	2450	1415	1680	1940	2450		
		Zone 1	1290	1545	1720	1935	2580	1545	1810	2070	2580		
		Zone 2	1310	1565	1740	1955	2600	1565	1830	2090	2600		
		Zone 3	1315	1570	1745	1960	2605	1570	1835	2095	2605		
		Zone 4	1325	1580	1755	1970	2615	1580	1845	2105	2615		
		Product Notes:											
		Pneumatic height adjustment and knee-tilt mechanism.											
		Optional swivel-tilt mechanism - reduce \$25 list , please specify.											
		Adjustable lumbar support mechanism.											
		Optional without lumbar support mechanism, please specify.											
Optional two-tone upholstery application - add \$125 list , please specify.													
Alternate polished aluminum base - add \$95 list , please specify (-1805 base).													
Wood base (1205) available in all Taylor finishes.													

Pyramid Form Style, Low Back

Model	Dimensions	Zone	COM	A	B	C	D	COL	L1	L2	L3		
9710.5PF-BA Ventura 	<div style="background-color: #ccc; padding: 5px; display: inline-block;">5 15</div> Width 24" Depth 27" Height 35 1/2" - 39 3/4" Seat Height 18 1/2" - 22 1/4" Seat Depth 18 3/4" Arm Height 25 3/4" - 29 1/2" Width/B Arms 19" Standard Base 1705 Alternate Base 1205, 1805 COM 3 1/4 yds. COL 44 sq. ft. Weight 60 lbs.	Will Call	1160	1415	1590	1805	2450	1415	1680	1940	2450		
		Zone 1	1290	1545	1720	1935	2580	1545	1810	2070	2580		
		Zone 2	1310	1565	1740	1955	2600	1565	1830	2090	2600		
		Zone 3	1315	1570	1745	1960	2605	1570	1835	2095	2605		
		Zone 4	1325	1580	1755	1970	2615	1580	1845	2105	2615		
		Product Notes:											
		Pneumatic height adjustment and knee-tilt mechanism.											
		Optional swivel-tilt mechanism - reduce \$25 list , please specify.											
		Adjustable lumbar support mechanism.											
		Optional without lumbar support mechanism, please specify.											
Optional two-tone upholstery application - add \$125 list , please specify.													
Alternate polished aluminum base - add \$95 list , please specify (-1805 base).													
Alternate wood base (1205) available in all Taylor finishes.													

Pyramid Form Style, Low Back, Black Polyurethane Arms

To specify, include:

- Model Number
- Wood Finish
- Fabric | Leather
- Quantity

Wood Finishes

- RCL Royal Cherry
- LWL Light Walnut
- ESP Espresso
- MHL Mahogany
- SMK Smoke
- CML Clear Maple
- COL Clear Oak
- CHY Cherry
- AMB Amber
- BLK Black

Graded-In Fabric | Leather

Specific grades for fabrics and leathers can be found on the separate grade cards found in your Taylor binder. For fabric and leather patterns not graded-in, please contact Customer Service for pricing.

Dimensions

Dimensions listed in this price book are in inches and approximate.

Freight

Zone list pricing includes freight prepaid by Taylor for delivery to one destination only within the zone. See pg. 5 for details.

Large Order Freight Discount

For orders with 20 units or more, please contact Customer Service for pricing.

Minimum Prepaid Freight Charges

Orders with 5 or less chairs (in any combination of guest, swivel, lounge, etc.) will be charged \$195 list per order.

5 | 15

Five Rooms in Fifteen Days

Seating marked with this logo is a part of Taylor's "Five Rooms in Fifteen Days" program. Refer to page 11 for details.

Model	Dimensions	Zone	COM	A	B	C	D	COL	L1	L2	L3		
9710.5SC Ventura 	<div style="background-color: #ccc; padding: 5px; display: inline-block;">5 15</div> Width 24" Depth 27" Height 35½" - 39¼" Seat Height 18½" - 22¼" Seat Depth 18¾" Arm Height 25¾" - 29½" Width/B Arms 19" Standard Base 1205 Alternate Base 1705, 1805 COM 3¼ yds. COL 44 sq. ft. Weight 63 lbs.	Will Call	1160	1415	1590	1805	2450	1415	1680	1940	2450		
		Zone 1	1290	1545	1720	1935	2580	1545	1810	2070	2580		
		Zone 2	1310	1565	1740	1955	2600	1565	1830	2090	2600		
		Zone 3	1315	1570	1745	1960	2605	1570	1835	2095	2605		
		Zone 4	1325	1580	1755	1970	2615	1580	1845	2105	2615		
		Product Notes:											
		Pneumatic height adjustment and knee-tilt mechanism.											
		Optional swivel-tilt mechanism - reduce \$25 list , please specify.											
		Adjustable lumbar support mechanism.											
		Optional without lumbar support mechanism, please specify.											
Alternate polished aluminum base - add \$95 list , please specify (-1805 base).													
Wood base (1205) available in all Taylor finishes.													

Soft Curve Style,
Low Back

9710.5SC-BA Ventura 	<div style="background-color: #ccc; padding: 5px; display: inline-block;">5 15</div> Width 24" Depth 27" Height 35½" - 39¼" Seat Height 18½" - 22¼" Seat Depth 18¾" Arm Height 25¾" - 29½" Width/B Arms 19" Standard Base 1705 Alternate Base 1205, 1805 COM 3¼ yds. COL 44 sq. ft. Weight 60 lbs.	Will Call	1160	1415	1590	1805	2450	1415	1680	1940	2450		
		Zone 1	1290	1545	1720	1935	2580	1545	1810	2070	2580		
		Zone 2	1310	1565	1740	1955	2600	1565	1830	2090	2600		
		Zone 3	1315	1570	1745	1960	2605	1570	1835	2095	2605		
		Zone 4	1325	1580	1755	1970	2615	1580	1845	2105	2615		
		Product Notes:											
		Pneumatic height adjustment and knee-tilt mechanism.											
		Optional swivel-tilt mechanism - reduce \$25 list , please specify.											
		Adjustable lumbar support mechanism.											
		Optional without lumbar support mechanism, please specify.											
Alternate polished aluminum base - add \$95 list , please specify (-1805 base).													
Alternate wood base (1205) available in all Taylor finishes.													

Soft Curve Style, Low Back,
Black Polyurethane Arms

9720.5CL Ventura 	<div style="background-color: #ccc; padding: 5px; display: inline-block;">5 15</div> Width 25½" Depth 27¼" Height 41½" - 45¼" Seat Height 18½" - 22¼" Seat Depth 19" Arm Height 26" - 29¾" Width/B Arms 18¾" Standard Base 1205 Alternate Base 1705, 1805 COM 5 yds. COL 68 sq. ft. Weight 66 lbs.	Will Call	1440	1625	1810	2015	2710	1625	1915	2155	2710		
		Zone 1	1570	1755	1940	2145	2840	1755	2045	2285	2840		
		Zone 2	1590	1775	1960	2165	2860	1775	2065	2305	2860		
		Zone 3	1595	1780	1965	2170	2865	1780	2070	2310	2865		
		Zone 4	1605	1790	1975	2180	2875	1790	2080	2320	2875		
		Product Notes:											
		Pneumatic height adjustment and knee-tilt mechanism.											
		Optional swivel-tilt mechanism - reduce \$25 list , please specify.											
		Adjustable lumbar support mechanism.											
		Optional without lumbar support mechanism, please specify.											
Alternate polished aluminum base - add \$95 list , please specify (-1805 base).													
Wood base (1205) available in all Taylor finishes.													

Classic Style,
High Back

To specify, include:

- Model Number
- Wood Finish
- Fabric | Leather
- Quantity

Wood Finishes

- RCL Royal Cherry
- LWL Light Walnut
- ESP Espresso
- MHL Mahogany
- SMK Smoke
- CML Clear Maple
- COL Clear Oak
- CHY Cherry
- AMB Amber
- BLK Black

Graded-In Fabric | Leather

Specific grades for fabrics and leathers can be found on the separate grade cards found in your Taylor binder. For fabric and leather patterns not graded-in, please contact Customer Service for pricing.

Dimensions

Dimensions listed in this price book are in inches and approximate.

Freight

Zone list pricing includes freight prepaid by Taylor for delivery to one destination only within the zone. See pg. 5 for details.

Large Order Freight Discount

For orders with 20 units or more, please contact Customer Service for pricing.

Minimum Prepaid Freight Charges

Orders with **5 or less chairs** (in any combination of guest, swivel, lounge, etc.) will be charged **\$195 list per order**.

5 | 15

Five Rooms in Fifteen Days

Seating marked with this logo is a part of Taylor's "Five Rooms in Fifteen Days" program. Refer to page 11 for details.

Model	Dimensions	Zone	COM	A	B	C	D	COL	L1	L2	L3																								
9720.5CL-BA Ventura	<div style="display: flex; align-items: center;"> <div style="background-color: #ccc; padding: 5px; margin-right: 10px;">5 15</div> <table border="0"> <tr><td>Width</td><td>24"</td></tr> <tr><td>Depth</td><td>27¼"</td></tr> <tr><td>Height</td><td>41½" - 45¼"</td></tr> <tr><td>Seat Height</td><td>18½" - 22¼"</td></tr> <tr><td>Seat Depth</td><td>19"</td></tr> <tr><td>Arm Height</td><td>26" - 29¾"</td></tr> <tr><td>Width/B Arms</td><td>18¾"</td></tr> <tr><td>Standard Base</td><td>1705</td></tr> <tr><td>Alternate Base</td><td>1205, 1805</td></tr> <tr><td>COM</td><td>5 yds.</td></tr> <tr><td>COL</td><td>68 sq. ft.</td></tr> <tr><td>Weight</td><td>63 lbs.</td></tr> </table> </div>	Width	24"	Depth	27¼"	Height	41½" - 45¼"	Seat Height	18½" - 22¼"	Seat Depth	19"	Arm Height	26" - 29¾"	Width/B Arms	18¾"	Standard Base	1705	Alternate Base	1205, 1805	COM	5 yds.	COL	68 sq. ft.	Weight	63 lbs.	Will Call	1440	1625	1810	2015	2710	1625	1915	2155	2710
		Width	24"																																
		Depth	27¼"																																
		Height	41½" - 45¼"																																
		Seat Height	18½" - 22¼"																																
		Seat Depth	19"																																
		Arm Height	26" - 29¾"																																
		Width/B Arms	18¾"																																
		Standard Base	1705																																
		Alternate Base	1205, 1805																																
COM	5 yds.																																		
COL	68 sq. ft.																																		
Weight	63 lbs.																																		
Zone 1	1570	1755	1940	2145	2840	1755	2045	2285	2840																										
Zone 2	1590	1775	1960	2165	2860	1775	2065	2305	2860																										
Zone 3	1595	1780	1965	2170	2865	1780	2070	2310	2865																										
Zone 4	1605	1790	1975	2180	2875	1790	2080	2320	2875																										



Classic Style, High Back, Black Polyurethane Arms

Product Notes:

- Pneumatic height adjustment and knee-tilt mechanism.
- Optional swivel-tilt mechanism - **reduce \$25 list**, please specify.
- Adjustable lumbar support mechanism.
- Optional without lumbar support mechanism, please specify.
- Alternate polished aluminum base - **add \$95 list**, please specify (-1805 base).
- Alternate wood base (1205) available in all Taylor finishes.

9720.5PF Ventura	<div style="display: flex; align-items: center;"> <div style="background-color: #ccc; padding: 5px; margin-right: 10px;">5 15</div> <table border="0"> <tr><td>Width</td><td>24"</td></tr> <tr><td>Depth</td><td>27¼"</td></tr> <tr><td>Height</td><td>41" - 44¾"</td></tr> <tr><td>Seat Height</td><td>18½" - 22¼"</td></tr> <tr><td>Seat Depth</td><td>18¾"</td></tr> <tr><td>Arm Height</td><td>25¾" - 29½"</td></tr> <tr><td>Width/B Arms</td><td>19"</td></tr> <tr><td>Standard Base</td><td>1205</td></tr> <tr><td>Alternate Base</td><td>1705, 1805</td></tr> <tr><td>COM</td><td>4¼ yds.</td></tr> <tr><td>COL</td><td>58 sq. ft.</td></tr> <tr><td>Weight</td><td>66 lbs.</td></tr> </table> </div>	Width	24"	Depth	27¼"	Height	41" - 44¾"	Seat Height	18½" - 22¼"	Seat Depth	18¾"	Arm Height	25¾" - 29½"	Width/B Arms	19"	Standard Base	1205	Alternate Base	1705, 1805	COM	4¼ yds.	COL	58 sq. ft.	Weight	66 lbs.	Will Call	1230	1485	1665	1885	2550	1485	1755	2025	2550
		Width	24"																																
		Depth	27¼"																																
		Height	41" - 44¾"																																
		Seat Height	18½" - 22¼"																																
		Seat Depth	18¾"																																
		Arm Height	25¾" - 29½"																																
		Width/B Arms	19"																																
		Standard Base	1205																																
		Alternate Base	1705, 1805																																
COM	4¼ yds.																																		
COL	58 sq. ft.																																		
Weight	66 lbs.																																		
Zone 1	1360	1615	1795	2015	2680	1615	1885	2155	2680																										
Zone 2	1380	1635	1815	2035	2700	1635	1905	2175	2700																										
Zone 3	1385	1640	1820	2040	2705	1640	1910	2180	2705																										
Zone 4	1395	1650	1830	2050	2715	1650	1920	2190	2715																										



Pyramid Form Style, High Back

Product Notes:

- Pneumatic height adjustment and knee-tilt mechanism.
- Optional swivel-tilt mechanism - **reduce \$25 list**, please specify.
- Adjustable lumbar support mechanism.
- Optional without lumbar support mechanism, please specify.
- Optional two-tone upholstery application - **add \$125 list**, please specify.
- Alternate polished aluminum base - **add \$95 list**, please specify (-1805 base).
- Wood base (1205) available in all Taylor finishes.

Two-Tone COM/COL

- COM (Pyramid-Inside Back) ¾ yd.
- COM (Remainder of Chair) 4¼ yds.
- COL (Pyramid-Inside Back) 3 sq. ft.
- COL (Remainder of Chair) 58 sq. ft.

9720.5PF-BA Ventura	<div style="display: flex; align-items: center;"> <div style="background-color: #ccc; padding: 5px; margin-right: 10px;">5 15</div> <table border="0"> <tr><td>Width</td><td>24"</td></tr> <tr><td>Depth</td><td>27¼"</td></tr> <tr><td>Height</td><td>41" - 44¾"</td></tr> <tr><td>Seat Height</td><td>18½" - 22¼"</td></tr> <tr><td>Seat Depth</td><td>18¾"</td></tr> <tr><td>Arm Height</td><td>25¾" - 29½"</td></tr> <tr><td>Width/B Arms</td><td>19"</td></tr> <tr><td>Standard Base</td><td>1705</td></tr> <tr><td>Alternate Base</td><td>1205, 1805</td></tr> <tr><td>COM</td><td>4¼ yds.</td></tr> <tr><td>COL</td><td>58 sq. ft.</td></tr> <tr><td>Weight</td><td>63 lbs.</td></tr> </table> </div>	Width	24"	Depth	27¼"	Height	41" - 44¾"	Seat Height	18½" - 22¼"	Seat Depth	18¾"	Arm Height	25¾" - 29½"	Width/B Arms	19"	Standard Base	1705	Alternate Base	1205, 1805	COM	4¼ yds.	COL	58 sq. ft.	Weight	63 lbs.	Will Call	1230	1485	1665	1885	2550	1485	1755	2025	2550
		Width	24"																																
		Depth	27¼"																																
		Height	41" - 44¾"																																
		Seat Height	18½" - 22¼"																																
		Seat Depth	18¾"																																
		Arm Height	25¾" - 29½"																																
		Width/B Arms	19"																																
		Standard Base	1705																																
		Alternate Base	1205, 1805																																
COM	4¼ yds.																																		
COL	58 sq. ft.																																		
Weight	63 lbs.																																		
Zone 1	1360	1615	1795	2015	2680	1615	1885	2155	2680																										
Zone 2	1380	1635	1815	2035	2700	1635	1905	2175	2700																										
Zone 3	1385	1640	1820	2040	2705	1640	1910	2180	2705																										
Zone 4	1395	1650	1830	2050	2715	1650	1920	2190	2715																										



Pyramid Form Style, High Back, Black Polyurethane Arms

Product Notes:

- Pneumatic height adjustment and knee-tilt mechanism.
- Optional swivel-tilt mechanism - **reduce \$25 list**, please specify.
- Adjustable lumbar support mechanism.
- Optional without lumbar support mechanism, please specify.
- Optional two-tone upholstery application - **add \$125 list**, please specify.
- Alternate polished aluminum base - **add \$95 list**, please specify (-1805 base).
- Alternate wood base (1205) available in all Taylor finishes.

Two-Tone COM/COL

- COM (Pyramid-Inside Back) ¾ yd.
- COM (Remainder of Chair) 4¼ yds.
- COL (Pyramid-Inside Back) 3 sq. ft.
- COL (Remainder of Chair) 58 sq. ft.

To specify, include:

- Model Number
- Wood Finish
- Fabric | Leather
- Quantity

Wood Finishes

- RCL Royal Cherry
- LWL Light Walnut
- ESP Espresso
- MHL Mahogany
- SMK Smoke
- CML Clear Maple
- COL Clear Oak
- CHY Cherry
- AMB Amber
- BLK Black

Graded-In Fabric | Leather

Specific grades for fabrics and leathers can be found on the separate grade cards found in your Taylor binder. For fabric and leather patterns not graded-in, please contact Customer Service for pricing.

Dimensions

Dimensions listed in this price book are in inches and approximate.

Freight

Zone list pricing includes freight prepaid by Taylor for delivery to one destination only within the zone. See pg. 5 for details.

Large Order Freight Discount

For orders with 20 units or more, please contact Customer Service for pricing.

Minimum Prepaid Freight Charges

Orders with **5 or less chairs** (in any combination of guest, swivel, lounge, etc.) will be charged **\$195 list per order**.

5 | 15

Five Rooms in Fifteen Days

Seating marked with this logo is a part of Taylor's "Five Rooms in Fifteen Days" program. Refer to page 11 for details.

Model	Dimensions	Zone	COM	A	B	C	D	COL	L1	L2	L3		
9720.5SC Ventura 	<div style="border: 1px solid black; padding: 2px; display: inline-block;">5 15</div> Width 24" Depth 27¼" Height 41" - 44¾" Seat Height 18½" - 22¼" Seat Depth 18¾" Arm Height 25¾" - 29½" Width/B Arms 19" Standard Base 1205 Alternate Base 1705, 1805 COM 4¼ yds. COL 58 sq. ft. Weight 66 lbs.	Will Call	1230	1485	1665	1885	2550	1485	1755	2025	2550		
		Zone 1	1360	1615	1795	2015	2680	1615	1885	2155	2680		
		Zone 2	1380	1635	1815	2035	2700	1635	1905	2175	2700		
		Zone 3	1385	1640	1820	2040	2705	1640	1910	2180	2705		
		Zone 4	1395	1650	1830	2050	2715	1650	1920	2190	2715		
		Product Notes:											
		Pneumatic height adjustment and knee-tilt mechanism.											
		Optional swivel-tilt mechanism - reduce \$25 list , please specify.											
		Adjustable lumbar support mechanism.											
		Optional without lumbar support mechanism, please specify.											
Alternate polished aluminum base - add \$95 list , please specify (-1805 base).													
Wood base (1205) available in all Taylor finishes.													

Soft Curve Style,
High Back

Model	Dimensions	Zone	COM	A	B	C	D	COL	L1	L2	L3		
9720.5SC-BA Ventura 	<div style="border: 1px solid black; padding: 2px; display: inline-block;">5 15</div> Width 24" Depth 27¼" Height 41" - 44¾" Seat Height 18½" - 22¼" Seat Depth 18¾" Arm Height 25¾" - 29½" Width/B Arms 19" Standard Base 1705 Alternate Base 1205, 1805 COM 4¼ yds. COL 58 sq. ft. Weight 63 lbs.	Will Call	1230	1485	1665	1885	2550	1485	1755	2025	2550		
		Zone 1	1360	1615	1795	2015	2680	1615	1885	2155	2680		
		Zone 2	1380	1635	1815	2035	2700	1635	1905	2175	2700		
		Zone 3	1385	1640	1820	2040	2705	1640	1910	2180	2705		
		Zone 4	1395	1650	1830	2050	2715	1650	1920	2190	2715		
		Product Notes:											
		Pneumatic height adjustment and knee-tilt mechanism.											
		Optional swivel-tilt mechanism - reduce \$25 list , please specify.											
		Adjustable lumbar support mechanism.											
		Optional without lumbar support mechanism, please specify.											
Alternate polished aluminum base - add \$95 list , please specify (-1805 base).													
Alternate wood base (1205) available in all Taylor finishes.													

Soft Curve Style, High Back,
Black Polyurethane Arms

To specify, include:

- Model Number
- Wood Finish
- Fabric | Leather
- Quantity

Wood Finishes

- RCL Royal Cherry
- LWL Light Walnut
- ESP Espresso
- MHL Mahogany
- SMK Smoke
- CML Clear Maple
- COL Clear Oak
- CHY Cherry
- AMB Amber
- BLK Black

Graded-In Fabric | Leather

Specific grades for fabrics and leathers can be found on the separate grade cards found in your Taylor binder. For fabric and leather patterns not graded-in, please contact Customer Service for pricing.

Dimensions

Dimensions listed in this price book are in inches and approximate.

Freight

Zone list pricing includes freight prepaid by Taylor for delivery to one destination only within the zone. See pg. 5 for details.

Large Order Freight Discount

For orders with 20 units or more, please contact Customer Service for pricing.

Minimum Prepaid Freight Charges

Orders with **5 or less chairs** (in any combination of guest, swivel, lounge, etc.) will be charged **\$195 list per order**.

5 | 15

Five Rooms in Fifteen Days

Seating marked with this logo is a part of Taylor's "Five Rooms in Fifteen Days" program. Refer to page 11 for details.

Model	Dimensions	Zone	COM	A	B	C	D	COL	L1	L2	L3	
2804-WLT Chippendale	Width	21¼"	Will Call	640	725	790	845	1065	725	820	910	1065
	Depth	24½"	Zone 1	725	810	875	930	1150	810	905	995	1150
	Height	36½"	Zone 2	735	820	885	940	1160	820	915	1005	1160
	Seat Height	19½"	Zone 3	740	825	890	945	1165	825	920	1010	1165
	Seat Depth	17½"	Zone 4	750	835	900	955	1175	835	930	1020	1175
	COM	2¼ yds.										
	COL	31 sq. ft.										
Weight	31 lbs.											

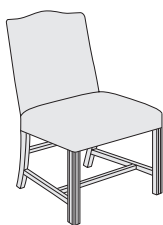

Armless

Product Notes:
Welt trim, not available with brass nails.
Available in all Taylor finishes.

2806
Chippendale

5 | 15

- Width 25½"
- Depth 27"
- Height 39"
- Seat Height 18½"
- Seat Depth 19½"
- Arm Height 26¾"
- Width/B Arms 19½"
- COM 2½ yds.
- COL 34 sq. ft.
- Weight 38 lbs.

Zone	COM	A	B	C	D	COL	L1	L2	L3
Will Call	915	1025	1070	1165	1465	1025	1110	1235	1465
Zone 1	1000	1110	1155	1250	1550	1110	1195	1320	1550
Zone 2	1010	1120	1165	1260	1560	1120	1205	1330	1560
Zone 3	1015	1125	1170	1265	1565	1125	1210	1335	1565
Zone 4	1025	1135	1180	1275	1575	1135	1220	1345	1575

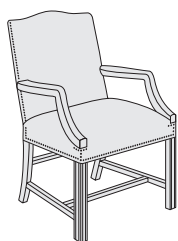

Exposed Wood Arms

Product Notes:
Optional welts in lieu of brass nails - **add \$75 list**, please specify.
Available in all Taylor finishes.

2806T
Chippendale

- Width 25½"
- Depth 27"
- Height 39"
- Seat Height 18½"
- Seat Depth 19½"
- Arm Height 26¾"
- Width/B Arms 19½"
- COM 2½ yds.
- COL 34 sq. ft.
- Weight 38 lbs.

Zone	COM	A	B	C	D	COL	L1	L2	L3
Will Call	985	1095	1140	1225	1540	1095	1175	1310	1540
Zone 1	1070	1180	1225	1310	1625	1180	1260	1395	1625
Zone 2	1080	1190	1235	1320	1635	1190	1270	1405	1635
Zone 3	1085	1195	1240	1325	1640	1195	1275	1410	1640
Zone 4	1095	1205	1250	1335	1650	1205	1285	1420	1650

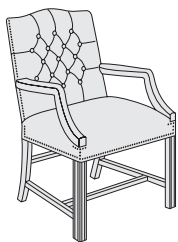

Exposed Wood Arms,
Tufted Back

Product Notes:
Optional welts in lieu of brass nails - **add \$75 list**, please specify.
Available in all Taylor finishes.

To specify, include:

- Model Number
- Wood Finish
- Fabric | Leather
- Quantity

Wood Finishes

- RCL Royal Cherry
- LWL Light Walnut
- ESP Espresso
- MHL Mahogany
- SMK Smoke
- CML Clear Maple
- COL Clear Oak
- CHY Cherry
- AMB Amber
- BLK Black

Graded-In Fabric | Leather

Specific grades for fabrics and leathers can be found on the separate grade cards found in your Taylor binder. For fabric and leather patterns not graded-in, please contact Customer Service for pricing.

Dimensions

Dimensions listed in this price book are in inches and approximate.

Freight

Zone list pricing includes freight prepaid by Taylor for delivery to one destination only within the zone. See pg. 5 for details.

Large Order Freight Discount

For orders with 20 units or more, please contact Customer Service for pricing.

Minimum Prepaid Freight Charges

Orders with 5 or less chairs (in any combination of guest, swivel, lounge, etc.) will be charged \$195 list per order.

5 | 15

Five Rooms in Fifteen Days

Seating marked with this logo is a part of Taylor's "Five Rooms in Fifteen Days" program. Refer to page 11 for details.

Model	Dimensions	Zone	COM	A	B	C	D	COL	L1	L2	L3	
2806-4 Chippendale	Width	25½"	Will Call	985	1095	1140	1225	1540	1095	1175	1310	1540
	Depth	27"	Zone 1	1070	1180	1225	1310	1625	1180	1260	1395	1625
	Height	39"	Zone 2	1080	1190	1235	1320	1635	1190	1270	1405	1635
	Seat Height	18½"	Zone 3	1085	1195	1240	1325	1640	1195	1275	1410	1640
	Seat Depth	19½"	Zone 4	1095	1205	1250	1335	1650	1205	1285	1420	1650
	Arm Height	26¾"										
	Width/B Arms	19½"										
	COM	2½ yds.										
	COL	34 sq. ft.										
	Weight	38 lbs.										

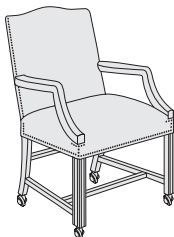

Exposed Wood Arms, Casters

Product Notes:

Optional welts in lieu of brass nails - add \$75 list, please specify. Available in all Taylor finishes.

Model	Dimensions	Zone	COM	A	B	C	D	COL	L1	L2	L3	
2806T-4 Chippendale	Width	25½"	Will Call	1060	1170	1210	1300	1610	1170	1245	1380	1610
	Depth	27"	Zone 1	1145	1255	1295	1385	1695	1255	1330	1465	1695
	Height	39"	Zone 2	1155	1265	1305	1395	1705	1265	1340	1475	1705
	Seat Height	18½"	Zone 3	1160	1270	1310	1400	1710	1270	1345	1480	1710
	Seat Depth	19½"	Zone 4	1170	1280	1320	1410	1720	1280	1355	1490	1720
	Arm Height	26¾"										
	Width/B Arms	19½"										
	COM	2½ yds.										
	COL	34 sq. ft.										
	Weight	38 lbs.										

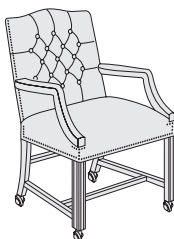

Exposed Wood Arms, Tufted Back, Casters

Product Notes:

Optional welts in lieu of brass nails - add \$75 list, please specify. Available in all Taylor finishes.

Model	Dimensions	Zone	COM	A	B	C	D	COL	L1	L2	L3	
2806UA Chippendale	Width	25½"	Will Call	975	1085	1180	1290	1585	1085	1265	1365	1585
	Depth	27"	Zone 1	1060	1170	1265	1375	1670	1170	1350	1450	1670
	Height	39"	Zone 2	1070	1180	1275	1385	1680	1180	1360	1460	1680
	Seat Height	18½"	Zone 3	1075	1185	1280	1390	1685	1185	1365	1465	1685
	Seat Depth	19½"	Zone 4	1085	1195	1290	1400	1695	1195	1375	1475	1695
	Arm Height	26¾"										
	Width/B Arms	19½"										
	COM	2½ yds.										
	COL	34 sq. ft.										
	Weight	38 lbs.										

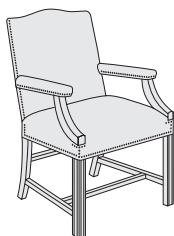

Upholstered Arm Caps

Product Notes:

Optional welts in lieu of brass nails - add \$75 list, please specify. Available in all Taylor finishes.

TRADITIONAL

To specify, include:

- Model Number
- Wood Finish
- Fabric | Leather
- Quantity

Wood Finishes

- RCL Royal Cherry
- LWL Light Walnut
- ESP Espresso
- MHL Mahogany
- SMK Smoke
- CML Clear Maple
- COL Clear Oak
- CHY Cherry
- AMB Amber
- BLK Black

Graded-In Fabric | Leather

Specific grades for fabrics and leathers can be found on the separate grade cards found in your Taylor binder. For fabric and leather patterns not graded-in, please contact Customer Service for pricing.

Dimensions

Dimensions listed in this price book are in inches and approximate.

Freight

Zone list pricing includes freight prepaid by Taylor for delivery to one destination only within the zone. See pg. 5 for details.

Large Order Freight Discount

For orders with 20 units or more, please contact Customer Service for pricing.

Minimum Prepaid Freight Charges

Orders with **5 or less chairs** (in any combination of guest, swivel, lounge, etc.) will be charged **\$195 list per order**.

5 | 15

Five Rooms in Fifteen Days

Seating marked with this logo is a part of Taylor's "Five Rooms in Fifteen Days" program. Refer to page 11 for details.

Model	Dimensions	Zone	COM	A	B	C	D	COL	L1	L2	L3	
2806TUA Chippendale	Width	25½"	Will Call	1050	1160	1250	1360	1660	1160	1335	1440	1660
	Depth	27"	Zone 1	1135	1245	1335	1445	1745	1245	1420	1525	1745
	Height	39"	Zone 2	1145	1255	1345	1455	1755	1255	1430	1535	1755
	Seat Height	18½"	Zone 3	1150	1260	1350	1460	1760	1260	1435	1540	1760
	Seat Depth	19½"	Zone 4	1160	1270	1360	1470	1770	1270	1445	1550	1770
	Arm Height	26¾"										
	Width/B Arms	19½"										
	COM	2½ yds.										
	COL	34 sq. ft.										
	Weight	38 lbs.										

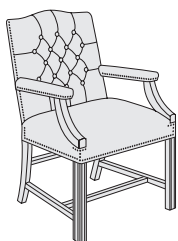

Upholstered Arm Caps,
Tufted Back

Product Notes:

Optional welts in lieu of brass nails - **add \$75 list**, please specify. Available in all Taylor finishes.

Model	Dimensions	Zone	COM	A	B	C	D	COL	L1	L2	L3	
2806UA-4 Chippendale	Width	25½"	Will Call	1050	1160	1250	1360	1660	1160	1335	1440	1660
	Depth	27"	Zone 1	1135	1245	1335	1445	1745	1245	1420	1525	1745
	Height	39"	Zone 2	1145	1255	1345	1455	1755	1255	1430	1535	1755
	Seat Height	18½"	Zone 3	1150	1260	1350	1460	1760	1260	1435	1540	1760
	Seat Depth	19½"	Zone 4	1160	1270	1360	1470	1770	1270	1445	1550	1770
	Arm Height	26¾"										
	Width/B Arms	19½"										
	COM	2½ yds.										
	COL	34 sq. ft.										
	Weight	38 lbs.										

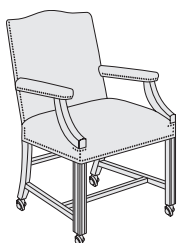

Upholstered Arm Caps,
Casters

Product Notes:

Optional welts in lieu of brass nails - **add \$75 list**, please specify. Available in all Taylor finishes.

Model	Dimensions	Zone	COM	A	B	C	D	COL	L1	L2	L3	
2806TUA-4 Chippendale	Width	25½"	Will Call	1120	1230	1325	1435	1730	1230	1410	1510	1730
	Depth	27"	Zone 1	1205	1315	1410	1520	1815	1315	1495	1595	1815
	Height	39"	Zone 2	1215	1325	1420	1530	1825	1325	1505	1605	1825
	Seat Height	18½"	Zone 3	1220	1330	1425	1535	1830	1330	1510	1610	1830
	Seat Depth	19½"	Zone 4	1230	1340	1435	1545	1840	1340	1520	1620	1840
	Arm Height	26¾"										
	Width/B Arms	19½"										
	COM	2½ yds.										
	COL	34 sq. ft.										
	Weight	38 lbs.										

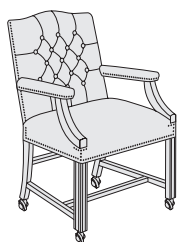

Upholstered Arm Caps,
Tufted Back, Casters

Product Notes:

Optional welts in lieu of brass nails - **add \$75 list**, please specify. Available in all Taylor finishes.

To specify, include:

- Model Number
- Wood Finish
- Fabric | Leather
- Quantity

Wood Finishes

- RCL Royal Cherry
- LWL Light Walnut
- ESP Espresso
- MHL Mahogany
- SMK Smoke
- CML Clear Maple
- COL Clear Oak
- CHY Cherry
- AMB Amber
- BLK Black

Graded-In Fabric | Leather

Specific grades for fabrics and leathers can be found on the separate grade cards found in your Taylor binder. For fabric and leather patterns not graded-in, please contact Customer Service for pricing.

Dimensions

Dimensions listed in this price book are in inches and approximate.

Freight

Zone list pricing includes freight prepaid by Taylor for delivery to one destination only within the zone. See pg. 5 for details.

Large Order Freight Discount

For orders with 20 units or more, please contact Customer Service for pricing.

Minimum Prepaid Freight Charges

Orders with 5 or less chairs (in any combination of guest, swivel, lounge, etc.) will be charged \$195 list per order.

5 | 15

Five Rooms in Fifteen Days

Seating marked with this logo is a part of Taylor's "Five Rooms in Fifteen Days" program. Refer to page 11 for details.

Model	Dimensions	Zone	COM	A	B	C	D	COL	L1	L2	L3	
2806CA Chippendale	Width	25½"	Will Call	1000	1105	1200	1310	1665	1105	1285	1390	1665
	Depth	27"	Zone 1	1085	1190	1285	1395	1750	1190	1370	1475	1750
	Height	39"	Zone 2	1095	1200	1295	1405	1760	1200	1380	1485	1760
	Seat Height	18½"	Zone 3	1100	1205	1300	1410	1765	1205	1385	1490	1765
	Seat Depth	19½"	Zone 4	1110	1215	1310	1420	1775	1215	1395	1500	1775
	Arm Height	26¾"										
	Width/B Arms	19"										
	COM	3½ yds.										
	COL	48 sq. ft.										
	Weight	39 lbs.										

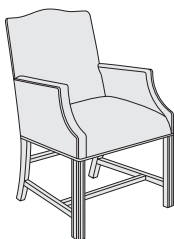

Closed Arms

Product Notes:

Optional welts in lieu of brass nails - add \$75 list, please specify. Available in all Taylor finishes.

Model	Dimensions	Zone	COM	A	B	C	D	COL	L1	L2	L3	
2806TCA Chippendale	Width	25½"	Will Call	1070	1180	1235	1380	1735	1180	1355	1460	1735
	Depth	27"	Zone 1	1155	1265	1320	1465	1820	1265	1440	1545	1820
	Height	39"	Zone 2	1165	1275	1330	1475	1830	1275	1450	1555	1830
	Seat Height	18½"	Zone 3	1170	1280	1335	1480	1835	1280	1455	1560	1835
	Seat Depth	19½"	Zone 4	1180	1290	1345	1490	1845	1290	1465	1570	1845
	Arm Height	26¾"										
	Width/B Arms	19"										
	COM	3½ yds.										
	COL	48 sq. ft.										
	Weight	39 lbs.										



Closed Arms,
Tufted Back

Product Notes:

Optional welts in lieu of brass nails - add \$75 list, please specify. Available in all Taylor finishes.

Model	Dimensions	Zone	COM	A	B	C	D	COL	L1	L2	L3	
2806CA-4 Chippendale	Width	25½"	Will Call	1070	1180	1275	1380	1735	1180	1355	1460	1735
	Depth	27"	Zone 1	1155	1265	1360	1465	1820	1265	1440	1545	1820
	Height	39"	Zone 2	1165	1275	1370	1475	1830	1275	1450	1555	1830
	Seat Height	18½"	Zone 3	1170	1280	1375	1480	1835	1280	1455	1560	1835
	Seat Depth	19½"	Zone 4	1180	1290	1385	1490	1845	1290	1465	1570	1845
	Arm Height	26¾"										
	Width/B Arms	19"										
	COM	3½ yds.										
	COL	48 sq. ft.										
	Weight	39 lbs.										

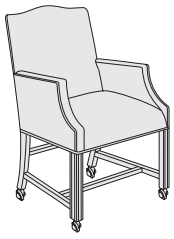

Closed Arms,
Casters

Product Notes:

Optional welts in lieu of brass nails - add \$75 list, please specify. Available in all Taylor finishes.

TRADITIONAL

To specify, include:

- Model Number
- Wood Finish
- Fabric | Leather
- Quantity

Wood Finishes

- RCL Royal Cherry
- LWL Light Walnut
- ESP Espresso
- MHL Mahogany
- SMK Smoke
- CML Clear Maple
- COL Clear Oak
- CHY Cherry
- AMB Amber
- BLK Black

Graded-In Fabric | Leather

Specific grades for fabrics and leathers can be found on the separate grade cards found in your Taylor binder. For fabric and leather patterns not graded-in, please contact Customer Service for pricing.

Dimensions

Dimensions listed in this price book are in inches and approximate.

Freight

Zone list pricing includes freight prepaid by Taylor for delivery to one destination only within the zone. See pg. 5 for details.

Large Order Freight Discount

For orders with 20 units or more, please contact Customer Service for pricing.

Minimum Prepaid Freight Charges

Orders with **5 or less chairs** (in any combination of guest, swivel, lounge, etc.) will be charged **\$195 list per order**.

5 | 15

Five Rooms in Fifteen Days

Seating marked with this logo is a part of Taylor's "Five Rooms in Fifteen Days" program. Refer to page 11 for details.

Model	Dimensions	Zone	COM	A	B	C	D	COL	L1	L2	L3	
2806TCA-4 Chippendale	Width	25½"	Will Call	1145	1250	1345	1455	1810	1250	1430	1535	1810
	Depth	27"	Zone 1	1230	1335	1430	1540	1895	1335	1515	1620	1895
	Height	39"	Zone 2	1240	1345	1440	1550	1905	1345	1525	1630	1905
	Seat Height	18½"	Zone 3	1245	1350	1445	1555	1910	1350	1530	1635	1910
	Seat Depth	19½"	Zone 4	1255	1360	1455	1565	1920	1360	1540	1645	1920
	Arm Height	26¾"										
	Width/B Arms	19"										
	COM	3½ yds.										
	COL	48 sq. ft.										
	Weight	39 lbs.										

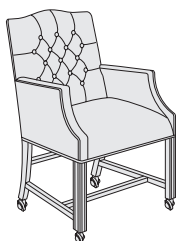

Closed Arms,
Tufted Back, Casters

Product Notes:

Optional welts in lieu of brass nails - **add \$75 list**, please specify. Available in all Taylor finishes.

Model	Dimensions	Zone	COM	A	B	C	D	COL	L1	L2	L3	
2806.5UA Chippendale	Width	25½"	Will Call	1160	1270	1360	1470	1765	1270	1445	1550	1765
	Depth	29¾"	Zone 1	1290	1400	1490	1600	1895	1400	1575	1680	1895
	Height	38" - 41¾"	Zone 2	1310	1420	1510	1620	1915	1420	1595	1700	1915
	Seat Height	18" - 21¾"	Zone 3	1315	1425	1515	1625	1920	1425	1600	1705	1920
	Seat Depth	19½"	Zone 4	1325	1435	1525	1635	1930	1435	1610	1715	1930
	Arm Height	25¼" - 29"										
	Width/B Arms	19"										
	Standard Base	705										
	Alternate Base	1405										
	COM	2½ yds.										



Upholstered Arm Caps

Product Notes:

Pneumatic height adjustment and swivel-tilt mechanism. Optional welts in lieu of brass nails - **add \$75 list**, please specify. Available in all Taylor finishes.

Model	Dimensions	Zone	COM	A	B	C	D	COL	L1	L2	L3	
2806.5TUA Chippendale	Width	25½"	Will Call	1230	1340	1435	1545	1840	1340	1520	1620	1840
	Depth	29¾"	Zone 1	1360	1470	1565	1675	1970	1470	1650	1750	1970
	Height	38" - 41¾"	Zone 2	1380	1490	1585	1695	1990	1490	1670	1770	1990
	Seat Height	18" - 21¾"	Zone 3	1385	1495	1590	1700	1995	1495	1675	1775	1995
	Seat Depth	19½"	Zone 4	1395	1505	1600	1710	2005	1505	1685	1785	2005
	Arm Height	25¼" - 29"										
	Width/B Arms	19"										
	Standard Base	705										
	Alternate Base	1405										
	COM	2½ yds.										



Upholstered Arm Caps,
Tufted Back

Product Notes:

Pneumatic height adjustment and swivel-tilt mechanism. Optional welts in lieu of brass nails - **add \$75 list**, please specify. Available in all Taylor finishes.

To specify, include:

- Model Number
- Wood Finish
- Fabric | Leather
- Quantity

Wood Finishes

- RCL Royal Cherry
- LWL Light Walnut
- ESP Espresso
- MHL Mahogany
- SMK Smoke
- CML Clear Maple
- COL Clear Oak
- CHY Cherry
- AMB Amber
- BLK Black

Graded-In Fabric | Leather

Specific grades for fabrics and leathers can be found on the separate grade cards found in your Taylor binder. For fabric and leather patterns not graded-in, please contact Customer Service for pricing.

Dimensions

Dimensions listed in this price book are in inches and approximate.

Freight

Zone list pricing includes freight prepaid by Taylor for delivery to one destination only within the zone. See pg. 5 for details.

Large Order Freight Discount

For orders with 20 units or more, please contact Customer Service for pricing.

Minimum Prepaid Freight Charges

Orders with 5 or less chairs (in any combination of guest, swivel, lounge, etc.) will be charged \$195 list per order.

5 | 15

Five Rooms in Fifteen Days

Seating marked with this logo is a part of Taylor's "Five Rooms in Fifteen Days" program. Refer to page 11 for details.

Model	Dimensions	Zone	COM	A	B	C	D	COL	L1	L2	L3	
2806.5CA Chippendale	Width	25½"	Will Call	1200	1310	1405	1510	1845	1310	1485	1590	1845
	Depth	29¾"	Zone 1	1330	1440	1535	1640	1975	1440	1615	1720	1975
	Height	38" - 41¾"	Zone 2	1350	1460	1555	1660	1995	1460	1635	1740	1995
	Seat Height	18" - 21¾"	Zone 3	1355	1465	1560	1665	2000	1465	1640	1745	2000
	Seat Depth	19½"	Zone 4	1365	1475	1570	1675	2010	1475	1650	1755	2010
	Arm Height	25¼" - 29"	Product Notes:									
	Width/B Arms	18"	Pneumatic height adjustment and swivel-tilt mechanism.									
	Standard Base	705	Optional welts in lieu of brass nails - add \$75 list , please specify.									
	Alternate Base	1405	Available in all Taylor finishes.									
	COM	3½ yds.										
COL	48 sq. ft.											
Weight	61 lbs.											



Closed Arms

2806.5TCA Chippendale	Width	25½"	Zone	COM	A	B	C	D	COL	L1	L2	L3
	Depth	29¾"	Will Call	1275	1380	1475	1585	1920	1380	1560	1665	1920
	Height	38" - 41¾"	Zone 1	1405	1510	1605	1715	2050	1510	1690	1795	2050
	Seat Height	18" - 21¾"	Zone 2	1425	1530	1625	1735	2070	1530	1710	1815	2070
	Seat Depth	19½"	Zone 3	1430	1535	1630	1740	2075	1535	1715	1820	2075
	Arm Height	25¼" - 29"	Zone 4	1440	1545	1640	1750	2085	1545	1725	1830	2085
	Width/B Arms	18"	Product Notes:									
	Standard Base	705	Pneumatic height adjustment and swivel-tilt mechanism.									
	Alternate Base	1405	Optional welts in lieu of brass nails - add \$75 list , please specify.									
	COM	3½ yds.	Available in all Taylor finishes.									
COL	48 sq. ft.											
Weight	61 lbs.											



Closed Arms,
Tufted Back

2807.5 Hepplewhite	Width	26"	Zone	COM	A	B	C	D	COL	L1	L2	L3
	Depth	26½"	Will Call	1215	1310	1405	1520	1865	1310	1455	1615	1865
	Height	33¾" - 37½"	Zone 1	1345	1440	1535	1650	1995	1440	1585	1745	1995
	Seat Height	17½" - 21¼"	Zone 2	1365	1460	1555	1670	2015	1460	1605	1765	2015
	Seat Depth	18"	Zone 3	1370	1465	1560	1675	2020	1465	1610	1770	2020
	Arm Height	25½" - 29¼"	Zone 4	1380	1475	1570	1685	2030	1475	1620	1780	2030
	Width/B Arms	22"	Product Notes:									
	Standard Base	705	Pneumatic height adjustment and swivel-tilt mechanism.									
	Alternate Base	1405	Optional welts in lieu of brass nails - add \$75 list , please specify.									
	COM	2½ yds.	Available in medium and dark Taylor finishes only .									
COL	34 sq. ft.											
Weight	66 lbs.											

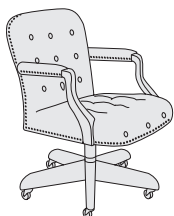

Fluted Arm Posts

TRADITIONAL

To specify, include:

- Model Number
- Wood Finish
- Fabric | Leather
- Quantity

Wood Finishes

- RCL Royal Cherry
- LWL Light Walnut
- ESP Espresso
- MHL Mahogany
- SMK Smoke
- CML Clear Maple
- COL Clear Oak
- CHY Cherry
- AMB Amber
- BLK Black

Graded-In Fabric | Leather

Specific grades for fabrics and leathers can be found on the separate grade cards found in your Taylor binder. For fabric and leather patterns not graded-in, please contact Customer Service for pricing.

Dimensions

Dimensions listed in this price book are in inches and approximate.

Freight

Zone list pricing includes freight prepaid by Taylor for delivery to one destination only within the zone. See pg. 5 for details.

Large Order Freight Discount

For orders with 20 units or more, please contact Customer Service for pricing.

Minimum Prepaid Freight Charges

Orders with **5 or less chairs** (in any combination of guest, swivel, lounge, etc.) will be charged **\$195 list per order**.

5|15

Five Rooms in Fifteen Days

Seating marked with this logo is a part of Taylor's "Five Rooms in Fifteen Days" program. Refer to page 11 for details.

Model	Dimensions	Zone	COM	A	B	C	D	COL	L1	L2	L3	
2808 Chippendale	Width	25"	Will Call	970	1080	1130	1220	1540	1080	1170	1315	1540
	Depth	26½"	Zone 1	1055	1165	1215	1305	1625	1165	1255	1400	1625
	Height	36½"	Zone 2	1065	1175	1225	1315	1635	1175	1265	1410	1635
	Seat Height	19"	Zone 3	1070	1180	1230	1320	1640	1180	1270	1415	1640
	Seat Depth	18½"	Zone 4	1080	1190	1240	1330	1650	1190	1280	1425	1650
	Arm Height	26½"										
	Width/B Arms	19½"										
	COM	2½ yds.										
	COL	34 sq. ft.										
	Weight	37 lbs.										

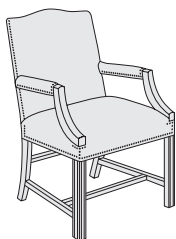

Upholstered Top Arms

Product Notes:

Optional welts in lieu of brass nails - **add \$75 list**, please specify. Available in all Taylor finishes.

Model	Dimensions	Zone	COM	A	B	C	D	COL	L1	L2	L3	
2808T Chippendale	Width	25"	Will Call	1045	1155	1200	1295	1610	1155	1240	1390	1610
	Depth	26½"	Zone 1	1130	1240	1285	1380	1695	1240	1325	1475	1695
	Height	36½"	Zone 2	1140	1250	1295	1390	1705	1250	1335	1485	1705
	Seat Height	19"	Zone 3	1145	1255	1300	1395	1710	1255	1340	1490	1710
	Seat Depth	18½"	Zone 4	1155	1265	1310	1405	1720	1265	1350	1500	1720
	Arm Height	26½"										
	Width/B Arms	19½"										
	COM	2½ yds.										
	COL	34 sq. ft.										
	Weight	37 lbs.										

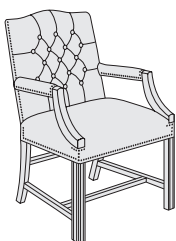

Upholstered Top Arms, Tufted Back

Product Notes:

Optional welts in lieu of brass nails - **add \$75 list**, please specify. Available in all Taylor finishes.

Model	Dimensions	Zone	COM	A	B	C	D	COL	L1	L2	L3	
2808CA Chippendale	Width	25"	Will Call	1055	1165	1210	1310	1755	1165	1250	1410	1755
	Depth	26½"	Zone 1	1140	1250	1295	1395	1840	1250	1335	1495	1840
	Height	36½"	Zone 2	1150	1260	1305	1405	1850	1260	1345	1505	1850
	Seat Height	19"	Zone 3	1155	1265	1310	1410	1855	1265	1350	1510	1855
	Seat Depth	18"	Zone 4	1165	1275	1320	1420	1865	1275	1360	1520	1865
	Arm Height	26½"										
	Width/B Arms	18"										
	COM	3½ yds.										
	COL	48 sq. ft.										
	Weight	38 lbs.										

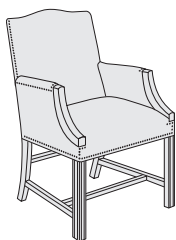

Closed Arms

Product Notes:

Optional welts in lieu of brass nails - **add \$75 list**, please specify. Available in all Taylor finishes.

To specify, include:

- Model Number
- Wood Finish
- Fabric | Leather
- Quantity

Wood Finishes

- RCL Royal Cherry
- LWL Light Walnut
- ESP Espresso
- MHL Mahogany
- SMK Smoke
- CML Clear Maple
- COL Clear Oak
- CHY Cherry
- AMB Amber
- BLK Black

Graded-In Fabric | Leather

Specific grades for fabrics and leathers can be found on the separate grade cards found in your Taylor binder. For fabric and leather patterns not graded-in, please contact Customer Service for pricing.

Dimensions

Dimensions listed in this price book are in inches and approximate.

Freight

Zone list pricing includes freight prepaid by Taylor for delivery to one destination only within the zone. See pg. 5 for details.

Large Order Freight Discount

For orders with 20 units or more, please contact Customer Service for pricing.

Minimum Prepaid Freight Charges

Orders with **5 or less chairs** (in any combination of guest, swivel, lounge, etc.) will be charged **\$195 list per order**.

5 | 15

Five Rooms in Fifteen Days

Seating marked with this logo is a part of Taylor's "Five Rooms in Fifteen Days" program. Refer to page 11 for details.

Model	Dimensions	Zone	COM	A	B	C	D	COL	L1	L2	L3	
2808TCA Chippendale	Width	25"	Will Call	1130	1235	1285	1380	1830	1235	1325	1480	1830
	Depth	26½"	Zone 1	1215	1320	1370	1465	1915	1320	1410	1565	1915
	Height	36½"	Zone 2	1225	1330	1380	1475	1925	1330	1420	1575	1925
	Seat Height	19"	Zone 3	1230	1335	1385	1480	1930	1335	1425	1580	1930
	Seat Depth	18½"	Zone 4	1240	1345	1395	1490	1940	1345	1435	1590	1940
	Arm Height	26½"										
	Width/B Arms	18"										
	COM	3½ yds.										
	COL	48 sq. ft.										
	Weight	38 lbs.										

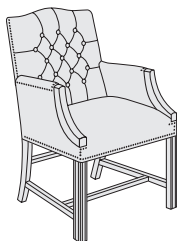

Closed Arms,
Tufted Back

Product Notes:

Optional welts in lieu of brass nails - **add \$75 list**, please specify. Available in all Taylor finishes.

Model	Dimensions	Zone	COM	A	B	C	D	COL	L1	L2	L3	
2808.5 Chippendale	Width	25"	Will Call	1180	1290	1335	1470	1795	1290	1375	1550	1795
	Depth	27¾"	Zone 1	1310	1420	1465	1600	1925	1420	1505	1680	1925
	Height	35" - 38¾"	Zone 2	1330	1440	1485	1620	1945	1440	1525	1700	1945
	Seat Height	18" - 21¾"	Zone 3	1335	1445	1490	1625	1950	1445	1530	1705	1950
	Seat Depth	19½"	Zone 4	1345	1455	1500	1635	1960	1455	1540	1715	1960
	Arm Height	24¼" - 28"										
	Width/B Arms	19½"										
	Standard Base	705										
	Alternate Base	1405										
	COM	2½ yds.										
COL	34 sq. ft.											
Weight	60 lbs.											



Upholstered Top Arms

Product Notes:

Pneumatic height adjustment and swivel-tilt mechanism. Optional welts in lieu of brass nails - **add \$75 list**, please specify. Available in all Taylor finishes.

Model	Dimensions	Zone	COM	A	B	C	D	COL	L1	L2	L3	
2808.5T Chippendale	Width	25"	Will Call	1250	1360	1410	1545	1865	1360	1450	1620	1865
	Depth	27¾"	Zone 1	1380	1490	1540	1675	1995	1490	1580	1750	1995
	Height	35" - 38¾"	Zone 2	1400	1510	1560	1695	2015	1510	1600	1770	2015
	Seat Height	18" - 21¾"	Zone 3	1405	1515	1565	1700	2020	1515	1605	1775	2020
	Seat Depth	19½"	Zone 4	1415	1525	1575	1710	2030	1525	1615	1785	2030
	Arm Height	24¼" - 28"										
	Width/B Arms	19½"										
	Standard Base	705										
	Alternate Base	1405										
	COM	2½ yds.										
COL	34 sq. ft.											
Weight	60 lbs.											



Upholstered Top Arms,
Tufted Back

Product Notes:

Pneumatic height adjustment and swivel-tilt mechanism. Optional welts in lieu of brass nails - **add \$75 list**, please specify. Available in all Taylor finishes.

TRADITIONAL

To specify, include:

- Model Number
- Wood Finish
- Fabric | Leather
- Quantity

Wood Finishes

- RCL Royal Cherry
- LWL Light Walnut
- ESP Espresso
- MHL Mahogany
- SMK Smoke
- CML Clear Maple
- COL Clear Oak
- CHY Cherry
- AMB Amber
- BLK Black

Graded-In Fabric | Leather

Specific grades for fabrics and leathers can be found on the separate grade cards found in your Taylor binder. For fabric and leather patterns not graded-in, please contact Customer Service for pricing.

Dimensions

Dimensions listed in this price book are in inches and approximate.

Freight

Zone list pricing includes freight prepaid by Taylor for delivery to one destination only within the zone. See pg. 5 for details.

Large Order Freight Discount

For orders with 20 units or more, please contact Customer Service for pricing.

Minimum Prepaid Freight Charges

Orders with **5 or less chairs** (in any combination of guest, swivel, lounge, etc.) will be charged **\$195 list per order**.

5 | 15

Five Rooms in Fifteen Days

Seating marked with this logo is a part of Taylor's "Five Rooms in Fifteen Days" program. Refer to page 11 for details.

Model	Dimensions	Zone	COM	A	B	C	D	COL	L1	L2	L3	
2808.5CA Chippendale	Width	25"	Will Call	1265	1370	1420	1520	1965	1370	1460	1615	1965
	Depth	27¾"	Zone 1	1395	1500	1550	1650	2095	1500	1590	1745	2095
	Height	35" - 38¾"	Zone 2	1415	1520	1570	1670	2115	1520	1610	1765	2115
	Seat Height	18" - 21¾"	Zone 3	1420	1525	1575	1675	2120	1525	1615	1770	2120
	Seat Depth	19½"	Zone 4	1430	1535	1585	1685	2130	1535	1625	1780	2130
	Arm Height	24¼" - 28"										
	Width/B Arms	18"										
	Standard Base	705										
	Alternate Base	1405										
	COM	3½ yds.										
COL	48 sq. ft.											
Weight	61 lbs.											



Closed Arms

Product Notes:

Pneumatic height adjustment and swivel-tilt mechanism. Optional welts in lieu of brass nails - **add \$75 list**, please specify. Available in all Taylor finishes.

Model	Dimensions	Zone	COM	A	B	C	D	COL	L1	L2	L3	
2808.5TCA Chippendale	Width	25"	Will Call	1335	1445	1490	1590	2040	1445	1535	1690	2040
	Depth	27¾"	Zone 1	1465	1575	1620	1720	2170	1575	1665	1820	2170
	Height	35" - 38¾"	Zone 2	1485	1595	1640	1740	2190	1595	1685	1840	2190
	Seat Height	18" - 21¾"	Zone 3	1490	1600	1645	1745	2195	1600	1690	1845	2195
	Seat Depth	19½"	Zone 4	1500	1610	1655	1755	2205	1610	1700	1855	2205
	Arm Height	24¼" - 28"										
	Width/B Arms	18"										
	Standard Base	705										
	Alternate Base	1405										
	COM	3½ yds.										
COL	48 sq. ft.											
Weight	61 lbs.											



Closed Arms,
Tufted Back

Product Notes:

Pneumatic height adjustment and swivel-tilt mechanism. Optional welts in lieu of brass nails - **add \$75 list**, please specify. Available in all Taylor finishes.

Model	Dimensions	Zone	COM	A	B	C	D	COL	L1	L2	L3	
2811.5 Traditional Executive	Width	30½"	Will Call	1680	1990	2200	2405	3090	1990	2305	2570	3090
	Depth	30¾"	Zone 1	1810	2120	2330	2535	3220	2120	2435	2700	3220
	Height	38¾" - 42½"	Zone 2	1830	2140	2350	2555	3240	2140	2455	2720	3240
	Seat Height	19¾" - 23½"	Zone 3	1835	2145	2355	2560	3245	2145	2460	2725	3245
	Seat Depth	19¼"	Zone 4	1845	2155	2365	2570	3255	2155	2470	2735	3255
	Arm Height	27" - 30¾"										
	Width/B Arms	18"										
	Standard Base	705										
	Alternate Base	1405										
	COM	5 yds.										
COL	68 sq. ft.											
Weight	81 lbs.											



Product Notes:

Pneumatic height adjustment and swivel-tilt mechanism. Optional welts in lieu of brass nails - **add \$110 list**, please specify. Available in all Taylor finishes.

To specify, include:

- Model Number
- Wood Finish
- Fabric | Leather
- Quantity

Wood Finishes

- RCL Royal Cherry
- LWL Light Walnut
- ESP Espresso
- MHL Mahogany
- SMK Smoke
- CML Clear Maple
- COL Clear Oak
- CHY Cherry
- AMB Amber
- BLK Black

Graded-In Fabric | Leather

Specific grades for fabrics and leathers can be found on the separate grade cards found in your Taylor binder. For fabric and leather patterns not graded-in, please contact Customer Service for pricing.

Dimensions

Dimensions listed in this price book are in inches and approximate.

Freight

Zone list pricing includes freight prepaid by Taylor for delivery to one destination only within the zone. See pg. 5 for details.

Large Order Freight Discount

For orders with 20 units or more, please contact Customer Service for pricing.

Minimum Prepaid Freight Charges

Orders with 5 or less chairs (in any combination of guest, swivel, lounge, etc.) will be charged \$195 list per order.

5 | 15

Five Rooms in Fifteen Days

Seating marked with this logo is a part of Taylor's "Five Rooms in Fifteen Days" program. Refer to page 11 for details.

Model	Dimensions	Zone	COM	A	B	C	D	COL	L1	L2	L3	
2811.5T Traditional Executive	Width	30½"	Will Call	1785	2095	2305	2510	3170	2095	2405	2670	3170
	Depth	31"	Zone 1	1915	2225	2435	2640	3300	2225	2535	2800	3300
	Height	38¾" - 42½"	Zone 2	1935	2245	2455	2660	3320	2245	2555	2820	3320
	Seat Height	19¾" - 23½"	Zone 3	1940	2250	2460	2665	3325	2250	2560	2825	3325
	Seat Depth	19¼"	Zone 4	1950	2260	2470	2675	3335	2260	2570	2835	3335
	Arm Height	27" - 30¾"	Product Notes:									
	Width/B Arms	18"	Pneumatic height adjustment and swivel-tilt mechanism.									
	Standard Base	705	Not available in vinyl upholstery.									
	Alternate Base	1405	Optional welts in lieu of brass nails - add \$110 list , please specify.									
	COM	5 yds.	Available in all Taylor finishes.									
COL	68 sq. ft.											
Weight	81 lbs.											

Hand-Fold Tufted Back and Seat

2811.5TLC
Traditional Executive

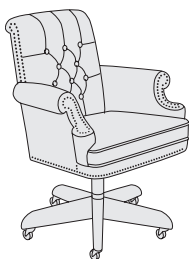

Hand-Fold Tufted Back, Loose Cushion Seat

Dimensions	Zone	COM	A	B	C	D	COL	L1	L2	L3	
Width	30½"	Will Call	1840	2150	2360	2570	3225	2150	2465	2725	3225
Depth	31"	Zone 1	1970	2280	2490	2700	3355	2280	2595	2855	3355
Height	38¾" - 42½"	Zone 2	1990	2300	2510	2720	3375	2300	2615	2875	3375
Seat Height	19¾" - 23½"	Zone 3	1995	2305	2515	2725	3380	2305	2620	2880	3380
Seat Depth	19"	Zone 4	2005	2315	2525	2735	3390	2315	2630	2890	3390
Arm Height	27" - 30¾"	Product Notes:									
Width/B Arms	18"	Pneumatic height adjustment and swivel-tilt mechanism.									
Standard Base	705	Not available in vinyl upholstery.									
Alternate Base	1405	Optional welts in lieu of brass nails - add \$110 list , please specify.									
COM	5 yds.	Available in all Taylor finishes.									
COL	68 sq. ft.										
Weight	81 lbs.										

2812.5
Traditional Executive

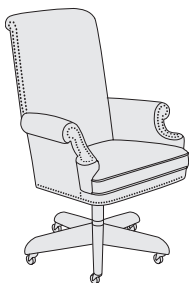

Dimensions	Zone	COM	A	B	C	D	COL	L1	L2	L3	
Width	30½"	Will Call	1735	2050	2255	2465	3170	2050	2360	2620	3170
Depth	31¼"	Zone 1	1865	2180	2385	2595	3300	2180	2490	2750	3300
Height	44½" - 48¼"	Zone 2	1885	2200	2405	2615	3320	2200	2510	2770	3320
Seat Height	19¾" - 23½"	Zone 3	1890	2205	2410	2620	3325	2205	2515	2775	3325
Seat Depth	19¼"	Zone 4	1900	2215	2420	2630	3335	2215	2525	2785	3335
Arm Height	27" - 30¾"	Product Notes:									
Width/B Arms	18"	Pneumatic height adjustment and swivel-tilt mechanism.									
Standard Base	705	Optional welts in lieu of brass nails - add \$110 list , please specify.									
Alternate Base	1405	Available in all Taylor finishes.									
COM	5¼ yds.										
COL	71 sq. ft.										
Weight	84 lbs.										

To specify, include:

- Model Number
- Wood Finish
- Fabric | Leather
- Quantity

Wood Finishes

- RCL Royal Cherry
- LWL Light Walnut
- ESP Espresso
- MHL Mahogany
- SMK Smoke
- CML Clear Maple
- COL Clear Oak
- CHY Cherry
- AMB Amber
- BLK Black

Graded-In Fabric | Leather

Specific grades for fabrics and leathers can be found on the separate grade cards found in your Taylor binder. For fabric and leather patterns not graded-in, please contact Customer Service for pricing.

Dimensions

Dimensions listed in this price book are in inches and approximate.

Freight

Zone list pricing includes freight prepaid by Taylor for delivery to one destination only within the zone. See pg. 5 for details.

Large Order Freight Discount

For orders with 20 units or more, please contact Customer Service for pricing.

Minimum Prepaid Freight Charges

Orders with **5 or less chairs** (in any combination of guest, swivel, lounge, etc.) will be charged **\$195 list per order**.

5 | 15

Five Rooms in Fifteen Days

Seating marked with this logo is a part of Taylor's "Five Rooms in Fifteen Days" program. Refer to page 11 for details.

Model	Dimensions	Zone	COM	A	B	C	D	COL	L1	L2	L3	
2812.5T Traditional Executive	Width	30½"	Will Call	1840	2150	2360	2570	3275	2150	2465	2725	3275
	Depth	31¼"	Zone 1	1970	2280	2490	2700	3405	2280	2595	2855	3405
	Height	44½" - 48¼"	Zone 2	1990	2300	2510	2720	3425	2300	2615	2875	3425
	Seat Height	19¾" - 23½"	Zone 3	1995	2305	2515	2725	3430	2305	2620	2880	3430
	Seat Depth	19¼"	Zone 4	2005	2315	2525	2735	3440	2315	2630	2890	3440
	Arm Height	27" - 30¾"										
	Width/B Arms	18"										
	Standard Base	705										
	Alternate Base	1405										
	COM	5¼ yds.										
COL	71 sq. ft.											
Weight	84 lbs.											

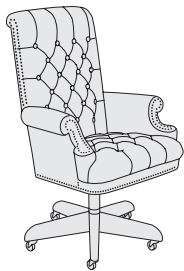

Hand-Fold Tufted Back and Seat

Product Notes:

Pneumatic height adjustment and swivel-tilt mechanism.
Not available in vinyl upholstery.
Optional welts in lieu of brass nails - **add \$110 list**, please specify.
Available in all Taylor finishes.

Model	Dimensions	Zone	COM	A	B	C	D	COL	L1	L2	L3	
2812.5TLC Traditional Executive	Width	30½"	Will Call	1890	2205	2410	2620	3325	2205	2515	2775	3325
	Depth	31¼"	Zone 1	2020	2335	2540	2750	3455	2335	2645	2905	3455
	Height	44½" - 48¼"	Zone 2	2040	2355	2560	2770	3475	2355	2665	2925	3475
	Seat Height	19¾" - 23½"	Zone 3	2045	2360	2565	2775	3480	2360	2670	2930	3480
	Seat Depth	19¼"	Zone 4	2055	2370	2575	2785	3490	2370	2680	2940	3490
	Arm Height	27" - 30¾"										
	Width/B Arms	18"										
	Standard Base	705										
	Alternate Base	1405										
	COM	5¼ yds.										
COL	71 sq. ft.											
Weight	84 lbs.											

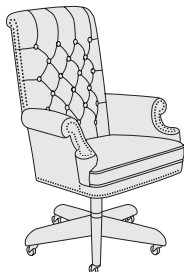

Hand-Fold Tufted Back, Loose Cushion Seat

Product Notes:

Pneumatic height adjustment and swivel-tilt mechanism.
Not available in vinyl upholstery.
Optional welts in lieu of brass nails - **add \$110 list**, please specify.
Available in all Taylor finishes.

Model	Dimensions	Zone	COM	A	B	C	D	COL	L1	L2	L3	
2813.5 Traditional Executive	Width	31½"	Will Call	1840	2150	2360	2570	3325	2150	2465	2725	3325
	Depth	31¼"	Zone 1	1970	2280	2490	2700	3455	2280	2595	2855	3455
	Height	44½" - 48¼"	Zone 2	1990	2300	2510	2720	3475	2300	2615	2875	3475
	Seat Height	19¾" - 23½"	Zone 3	1995	2305	2515	2725	3480	2305	2620	2880	3480
	Seat Depth	19¼"	Zone 4	2005	2315	2525	2735	3490	2315	2630	2890	3490
	Arm Height	27" - 30¾"										
	Width/B Arms	18"										
	Standard Base	705										
	Alternate Base	1405										
	COM	5¾ yds.										
COL	78 sq. ft.											
Weight	86 lbs.											

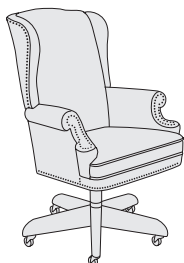

Product Notes:

Pneumatic height adjustment and swivel-tilt mechanism.
Optional welts in lieu of brass nails - **add \$110 list**, please specify.
Available in all Taylor finishes.

To specify, include:

- Model Number
- Wood Finish
- Fabric | Leather
- Quantity

Wood Finishes

- RCL Royal Cherry
- LWL Light Walnut
- ESP Espresso
- MHL Mahogany
- SMK Smoke
- CML Clear Maple
- COL Clear Oak
- CHY Cherry
- AMB Amber
- BLK Black

Graded-In Fabric | Leather

Specific grades for fabrics and leathers can be found on the separate grade cards found in your Taylor binder. For fabric and leather patterns not graded-in, please contact Customer Service for pricing.

Dimensions

Dimensions listed in this price book are in inches and approximate.

Freight

Zone list pricing includes freight prepaid by Taylor for delivery to one destination only within the zone. See pg. 5 for details.

Large Order Freight Discount

For orders with 20 units or more, please contact Customer Service for pricing.

Minimum Prepaid Freight Charges

Orders with 5 or less chairs (in any combination of guest, swivel, lounge, etc.) will be charged \$195 list per order.

5 | 15

Five Rooms in Fifteen Days

Seating marked with this logo is a part of Taylor's "Five Rooms in Fifteen Days" program. Refer to page 11 for details.

Model	Dimensions	Zone	COM	A	B	C	D	COL	L1	L2	L3	
2813.5T Traditional Executive	Width	31½"	Will Call	1945	2255	2465	2670	3430	2255	2570	2830	3430
	Depth	31¼"	Zone 1	2075	2385	2595	2800	3560	2385	2700	2960	3560
	Height	44½" - 48¼"	Zone 2	2095	2405	2615	2820	3580	2405	2720	2980	3580
	Seat Height	19¾" - 23½"	Zone 3	2100	2410	2620	2825	3585	2410	2725	2985	3585
	Seat Depth	19¼"	Zone 4	2110	2420	2630	2835	3595	2420	2735	2995	3595
	Arm Height	27" - 30¾"	Product Notes:									
	Width/B Arms	18"	Pneumatic height adjustment and swivel-tilt mechanism.									
	Standard Base	705	Not available in vinyl upholstery.									
	Alternate Base	1405	Optional welts in lieu of brass nails - add \$110 list , please specify.									
	COM	5¾ yds.	Available in all Taylor finishes.									
COL	78 sq. ft.											
Weight	86 lbs.											

Hand-Fold Tufted Back and Seat

2813.5TLC Traditional Executive	Width	31½"	Zone	COM	A	B	C	D	COL	L1	L2	L3
	Depth	31¼"	Will Call	1995	2310	2515	2725	3485	2310	2620	2880	3485
	Height	44½" - 48¼"	Zone 1	2125	2440	2645	2855	3615	2440	2750	3010	3615
	Seat Height	19¾" - 23½"	Zone 2	2145	2460	2665	2875	3635	2460	2770	3030	3635
	Seat Depth	19¼"	Zone 3	2150	2465	2670	2880	3640	2465	2775	3035	3640
	Arm Height	27" - 30¾"	Zone 4	2160	2475	2680	2890	3650	2475	2785	3045	3650
	Width/B Arms	18"	Product Notes:									
	Standard Base	705	Pneumatic height adjustment and swivel-tilt mechanism.									
	Alternate Base	1405	Not available in vinyl upholstery.									
	COM	5¾ yds.	Optional welts in lieu of brass nails - add \$110 list , please specify.									
COL	78 sq. ft.	Available in all Taylor finishes.										
Weight	86 lbs.											

Hand-Fold Tufted Back, Loose Cushion Seat

2814 English Hepplewhite	Width	24"	Zone	COM	A	B	C	D	COL	L1	L2	L3
	Depth	27"	Will Call	1055	1215	1350	1490	1935	1215	1445	1590	1935
	Height	33½"	Zone 1	1140	1300	1435	1575	2020	1300	1530	1675	2020
	Seat Height	19"	Zone 2	1150	1310	1445	1585	2030	1310	1540	1685	2030
	Seat Depth	19"	Zone 3	1155	1315	1450	1590	2035	1315	1545	1690	2035
	Arm Height	27"	Zone 4	1165	1325	1460	1600	2045	1325	1555	1700	2045
	Width/B Arms	20"	Product Notes:									
	COM	2¾ yds.	Optional welts in lieu of brass nails - add \$75 list , please specify.									
	COL	40 sq. ft.	Available in all Taylor finishes.									
	Weight	35 lbs.										

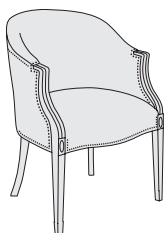

TRADITIONAL

To specify, include:

- Model Number
- Wood Finish
- Fabric | Leather
- Quantity

Wood Finishes

- RCL Royal Cherry
- LWL Light Walnut
- ESP Espresso
- MHL Mahogany
- SMK Smoke
- CML Clear Maple
- COL Clear Oak
- CHY Cherry
- AMB Amber
- BLK Black

Graded-In Fabric | Leather

Specific grades for fabrics and leathers can be found on the separate grade cards found in your Taylor binder. For fabric and leather patterns not graded-in, please contact Customer Service for pricing.

Dimensions

Dimensions listed in this price book are in inches and approximate.

Freight

Zone list pricing includes freight prepaid by Taylor for delivery to one destination only within the zone. See pg. 5 for details.

Large Order Freight Discount

For orders with 20 units or more, please contact Customer Service for pricing.

Minimum Prepaid Freight Charges

Orders with 5 or less chairs (in any combination of guest, swivel, lounge, etc.) will be charged \$195 list per order.

5/15

Five Rooms in Fifteen Days

Seating marked with this logo is a part of Taylor's "Five Rooms in Fifteen Days" program. Refer to page 11 for details.

Model	Dimensions	Zone	COM	A	B	C	D	COL	L1	L2	L3	
2814T English Hepplewhite	Width	24"	Will Call	1115	1280	1415	1555	1995	1280	1505	1655	1995
	Depth	27"	Zone 1	1200	1365	1500	1640	2080	1365	1590	1740	2080
	Height	33½"	Zone 2	1210	1375	1510	1650	2090	1375	1600	1750	2090
	Seat Height	19"	Zone 3	1215	1380	1515	1655	2095	1380	1605	1755	2095
	Seat Depth	19"	Zone 4	1225	1390	1525	1665	2105	1390	1615	1765	2105
	Arm Height	27"										
	Width/B Arms	20"										
	COM	2¾ yds.										
	COL	40 sq. ft.										
	Weight	35 lbs.										

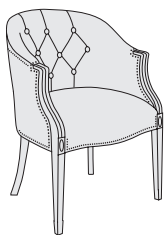

Tufted Back

Product Notes:
Optional welts in lieu of brass nails - add \$75 list, please specify. Available in all Taylor finishes.

Model	Dimensions	Zone	COM	A	B	C	D	COL	L1	L2	L3	
2814-4 English Hepplewhite	Width	24"	Will Call	1130	1290	1425	1565	2005	1290	1520	1665	2005
	Depth	27"	Zone 1	1215	1375	1510	1650	2090	1375	1605	1750	2090
	Height	33½"	Zone 2	1225	1385	1520	1660	2100	1385	1615	1760	2100
	Seat Height	19"	Zone 3	1230	1390	1525	1665	2105	1390	1620	1765	2105
	Seat Depth	19"	Zone 4	1240	1400	1535	1675	2115	1400	1630	1775	2115
	Arm Height	27"										
	Width/B Arms	20"										
	COM	2¾ yds.										
	COL	40 sq. ft.										
	Weight	37 lbs.										

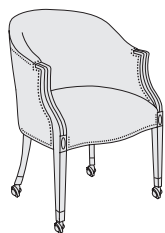

Casters

Product Notes:
Optional welts in lieu of brass nails - add \$75 list, please specify. Available in all Taylor finishes.

Model	Dimensions	Zone	COM	A	B	C	D	COL	L1	L2	L3	
2814T-4 English Hepplewhite	Width	24"	Will Call	1190	1350	1485	1625	2070	1350	1580	1725	2070
	Depth	27"	Zone 1	1275	1435	1570	1710	2155	1435	1665	1810	2155
	Height	33½"	Zone 2	1285	1445	1580	1720	2165	1445	1675	1820	2165
	Seat Height	19"	Zone 3	1290	1450	1585	1725	2170	1450	1680	1825	2170
	Seat Depth	19"	Zone 4	1300	1460	1595	1735	2180	1460	1690	1835	2180
	Arm Height	27"										
	Width/B Arms	20"										
	COM	2¾ yds.										
	COL	40 sq. ft.										
	Weight	37 lbs.										

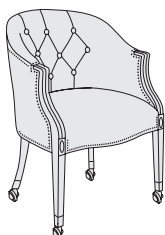

Tufted Back, Casters

Product Notes:
Optional welts in lieu of brass nails - add \$75 list, please specify. Available in all Taylor finishes.

To specify, include:

- Model Number
- Wood Finish
- Fabric | Leather
- Quantity

Wood Finishes

- RCL Royal Cherry
- LWL Light Walnut
- ESP Espresso
- MHL Mahogany
- SMK Smoke
- CML Clear Maple
- COL Clear Oak
- CHY Cherry
- AMB Amber
- BLK Black

Graded-In Fabric | Leather

Specific grades for fabrics and leathers can be found on the separate grade cards found in your Taylor binder. For fabric and leather patterns not graded-in, please contact Customer Service for pricing.

Dimensions

Dimensions listed in this price book are in inches and approximate.

Freight

Zone list pricing includes freight prepaid by Taylor for delivery to one destination only within the zone. See pg. 5 for details.

Large Order Freight Discount

For orders with 20 units or more, please contact Customer Service for pricing.

Minimum Prepaid Freight Charges

Orders with **5 or less chairs** (in any combination of guest, swivel, lounge, etc.) will be charged **\$195 list per order**.

5 | 15

Five Rooms in Fifteen Days

Seating marked with this logo is a part of Taylor's "Five Rooms in Fifteen Days" program. Refer to page 11 for details.

Model	Dimensions	Zone	COM	A	B	C	D	COL	L1	L2	L3	
2814.5 English Hepplewhite	Width	24"	Will Call	1260	1400	1535	1675	2115	1400	1610	1770	2115
	Depth	27"	Zone 1	1390	1530	1665	1805	2245	1530	1740	1900	2245
	Height	31" - 34¾"	Zone 2	1410	1550	1685	1825	2265	1550	1760	1920	2265
	Seat Height	18¼" - 21½"	Zone 3	1415	1555	1690	1830	2270	1555	1765	1925	2270
	Seat Depth	19"	Zone 4	1425	1565	1700	1840	2280	1565	1775	1935	2280
	Arm Height	25" - 28¾"										
	Width/B Arms	20"										
	Standard Base	705										
	Alternate Base	1405										
	COM	2¾ yds.										
COL	40 sq. ft.											
Weight	61 lbs.											



Product Notes:

Pneumatic height adjustment and swivel-tilt mechanism. Optional welts in lieu of brass nails - **add \$75 list**, please specify. Available in all Taylor finishes.

2814.5T English Hepplewhite	Width	24"	Zone	COM	A	B	C	D	COL	L1	L2	L3
	Depth	27"	Will Call	1320	1460	1595	1735	2180	1460	1675	1835	2180
	Height	31" - 34¾"	Zone 1	1450	1590	1725	1865	2310	1590	1805	1965	2310
	Seat Height	18¼" - 21½"	Zone 2	1470	1610	1745	1885	2330	1610	1825	1985	2330
	Seat Depth	19"	Zone 3	1475	1615	1750	1890	2335	1615	1830	1990	2335
	Arm Height	25" - 28¾"	Zone 4	1485	1625	1760	1900	2345	1625	1840	2000	2345
	Width/B Arms	20"										
	Standard Base	705										
	Alternate Base	1405										
	COM	2¾ yds.										
COL	40 sq. ft.											
Weight	61 lbs.											

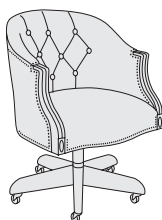

Tufted Back

Product Notes:

Pneumatic height adjustment and swivel-tilt mechanism. Optional welts in lieu of brass nails - **add \$75 list**, please specify. Available in all Taylor finishes.

2816 English Hepplewhite	Width	24"	Zone	COM	A	B	C	D	COL	L1	L2	L3
	Depth	27"	Will Call	1035	1195	1340	1480	1915	1195	1425	1575	1915
	Height	33½"	Zone 1	1120	1280	1425	1565	2000	1280	1510	1660	2000
	Seat Height	19"	Zone 2	1130	1290	1435	1575	2010	1290	1520	1670	2010
	Seat Depth	19"	Zone 3	1135	1295	1440	1580	2015	1295	1525	1675	2015
	Arm Height	27"	Zone 4	1145	1305	1450	1590	2025	1305	1535	1685	2025
	Width/B Arms	20"										
	COM	2¾ yds.										
	COL	40 sq. ft.										
	Weight	37 lbs.										

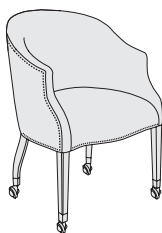

Fully Upholstered, Casters

Product Notes:

Optional welts in lieu of brass nails - **add \$75 list**, please specify. Available in all Taylor finishes.

TRADITIONAL

To specify, include:

- Model Number
- Wood Finish
- Fabric | Leather
- Quantity

Wood Finishes

- RCL Royal Cherry
- LWL Light Walnut
- ESP Espresso
- MHL Mahogany
- SMK Smoke
- CML Clear Maple
- COL Clear Oak
- CHY Cherry
- AMB Amber
- BLK Black

Graded-In Fabric | Leather

Specific grades for fabrics and leathers can be found on the separate grade cards found in your Taylor binder. For fabric and leather patterns not graded-in, please contact Customer Service for pricing.

Dimensions

Dimensions listed in this price book are in inches and approximate.

Freight

Zone list pricing includes freight prepaid by Taylor for delivery to one destination only within the zone. See pg. 5 for details.

Large Order Freight Discount

For orders with 20 units or more, please contact Customer Service for pricing.

Minimum Prepaid Freight Charges

Orders with **5 or less chairs** (in any combination of guest, swivel, lounge, etc.) will be charged **\$195 list per order**.

5 | 15

Five Rooms in Fifteen Days

Seating marked with this logo is a part of Taylor's "Five Rooms in Fifteen Days" program. Refer to page 11 for details.

Model	Dimensions	Zone	COM	A	B	C	D	COL	L1	L2	L3	
2816T English Hepplewhite	Width	24"	Will Call	1105	1270	1415	1555	1985	1270	1495	1650	1985
	Depth	27"	Zone 1	1190	1355	1500	1640	2070	1355	1580	1735	2070
	Height	33½"	Zone 2	1200	1365	1510	1650	2080	1365	1590	1745	2080
	Seat Height	19"	Zone 3	1205	1370	1515	1655	2085	1370	1595	1750	2085
	Seat Depth	19"	Zone 4	1215	1380	1525	1665	2095	1380	1605	1760	2095
	Arm Height	27"										
	Width/B Arms	20"										
	COM	2¾ yds.										
	COL	40 sq. ft.										
	Weight	37 lbs.										

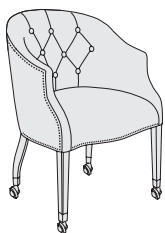

Fully Upholstered,
Tufted Back, Casters

Product Notes:

Optional welts in lieu of brass nails - **add \$75 list**, please specify. Available in all Taylor finishes.

Model	Dimensions	Zone	COM	A	B	C	D	COL	L1	L2	L3	
2816.5 English Hepplewhite	Width	24"	Will Call	1215	1375	1525	1665	2105	1375	1605	1760	2105
	Depth	27"	Zone 1	1345	1505	1655	1795	2235	1505	1735	1890	2235
	Height	31" - 34¾"	Zone 2	1365	1525	1675	1815	2255	1525	1755	1910	2255
	Seat Height	18¼" - 21½"	Zone 3	1370	1530	1680	1820	2260	1530	1760	1915	2260
	Seat Depth	19"	Zone 4	1380	1540	1690	1830	2270	1540	1770	1925	2270
	Arm Height	25" - 28¾"										
	Width/B Arms	19¾"										
	Standard Base	705										
	Alternate Base	1405										
	COM	2¾ yds.										



Fully Upholstered

Product Notes:

Pneumatic height adjustment and swivel-tilt mechanism. Optional welts in lieu of brass nails - **add \$75 list**, please specify. Available in all Taylor finishes.

Model	Dimensions	Zone	COM	A	B	C	D	COL	L1	L2	L3	
2816.5T English Hepplewhite	Width	24"	Will Call	1290	1450	1595	1735	2180	1450	1680	1835	2180
	Depth	27"	Zone 1	1420	1580	1725	1865	2310	1580	1810	1965	2310
	Height	31" - 34¾"	Zone 2	1440	1600	1745	1885	2330	1600	1830	1985	2330
	Seat Height	18¼" - 21½"	Zone 3	1445	1605	1750	1890	2335	1605	1835	1990	2335
	Seat Depth	19"	Zone 4	1455	1615	1760	1900	2345	1615	1845	2000	2345
	Arm Height	25" - 28¾"										
	Width/B Arms	19¾"										
	Standard Base	705										
	Alternate Base	1405										
	COM	2¾ yds.										

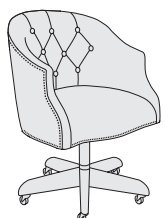

Fully Upholstered
Tufted Back

Product Notes:

Pneumatic height adjustment and swivel-tilt mechanism. Optional welts in lieu of brass nails - **add \$75 list**, please specify. Available in all Taylor finishes.

To specify, include:

- Model Number
- Wood Finish
- Fabric | Leather
- Quantity

Wood Finishes

- RCL Royal Cherry
- LWL Light Walnut
- ESP Espresso
- MHL Mahogany
- SMK Smoke
- CML Clear Maple
- COL Clear Oak
- CHY Cherry
- AMB Amber
- BLK Black

Graded-In Fabric | Leather

Specific grades for fabrics and leathers can be found on the separate grade cards found in your Taylor binder. For fabric and leather patterns not graded-in, please contact Customer Service for pricing.

Dimensions

Dimensions listed in this price book are in inches and approximate.

Freight

Zone list pricing includes freight prepaid by Taylor for delivery to one destination only within the zone. See pg. 5 for details.

Large Order Freight Discount

For orders with 20 units or more, please contact Customer Service for pricing.

Minimum Prepaid Freight Charges

Orders with **5 or less chairs** (in any combination of guest, swivel, lounge, etc.) will be charged **\$195 list per order**.

5 | 15

Five Rooms in Fifteen Days

Seating marked with this logo is a part of Taylor's "Five Rooms in Fifteen Days" program. Refer to page 11 for details.

Model	Dimensions	Zone	COM	A	B	C	D	COL	L1	L2	L3	
2818 Courthouse	Width	24"	Will Call	1160	1320	1415	1540	1910	1320	1465	1650	1910
	Depth	26¼"	Zone 1	1245	1405	1500	1625	1995	1405	1550	1735	1995
	Height	33"	Zone 2	1255	1415	1510	1635	2005	1415	1560	1745	2005
	Seat Height	18¾"	Zone 3	1260	1420	1515	1640	2010	1420	1565	1750	2010
	Seat Depth	20"	Zone 4	1270	1430	1525	1650	2020	1430	1575	1760	2020
	Arm Height	27¼"										
	Width/B Arms	20½"										
	COM	2¾ yds.										
COL	38 sq. ft.											
Weight	36 lbs.											

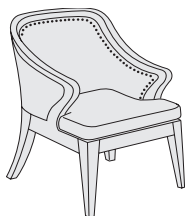

Steam Bent Top Rail

Product Notes:

Optional welts in lieu of brass nails - **add \$75 list**, please specify. Available in all Taylor finishes.

Model	Dimensions	Zone	COM	A	B	C	D	COL	L1	L2	L3	
2819 Captain	Width	26½"	Will Call	745	805	845	900	1155	805	870	960	1155
	Depth	28"	Zone 1	830	890	930	985	1240	890	955	1045	1240
	Height	30¼"	Zone 2	840	900	940	995	1250	900	965	1055	1250
	Seat Height	18"	Zone 3	845	905	945	1000	1255	905	970	1060	1255
	Seat Depth	19"	Zone 4	855	915	955	1010	1265	915	980	1070	1265
	Arm Height	27"										
	Width/B Arms	18¾"										
	COM	1¾ yds.										
COL	24 sq. ft.											
Weight	28 lbs.											



Product Notes:

Available in all Taylor finishes.

Model	Dimensions	Zone	COM	A	B	C	D	COL	L1	L2	L3	
2831 Chippendale Lounge	Width	34"	Will Call	1840	2155	2425	2700	3500	2155	2590	2870	3500
	Depth	33"	Zone 1	2030	2345	2615	2890	3690	2345	2780	3060	3690
	Height	42½"	Zone 2	2065	2380	2650	2925	3725	2380	2815	3095	3725
	Seat Height	18½"	Zone 3	2070	2385	2655	2930	3730	2385	2820	3100	3730
	Seat Depth	20½"	Zone 4	2080	2395	2665	2940	3740	2395	2830	3110	3740
	Arm Height	26"										
	Width/B Arms	21½"										
	COM	7¾ yds.										
COL	105 sq. ft.											
Weight	70 lbs.											

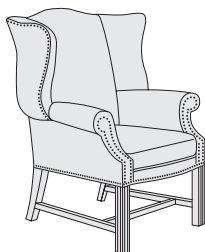

Loose Cushion Seat

Product Notes:

Optional welts in lieu of brass nails - **add \$150 list**, please specify. Available in **medium and dark Taylor finishes only**.

TRADITIONAL

To specify, include:

- Model Number
- Wood Finish
- Fabric | Leather
- Quantity

Wood Finishes

- RCL Royal Cherry
- LWL Light Walnut
- ESP Espresso
- MHL Mahogany
- SMK Smoke
- CML Clear Maple
- COL Clear Oak
- CHY Cherry
- AMB Amber
- BLK Black

Graded-In Fabric | Leather

Specific grades for fabrics and leathers can be found on the separate grade cards found in your Taylor binder. For fabric and leather patterns not graded-in, please contact Customer Service for pricing.

Dimensions

Dimensions listed in this price book are in inches and approximate.

Freight

Zone list pricing includes freight prepaid by Taylor for delivery to one destination only within the zone. See pg. 5 for details.

Large Order Freight Discount

For orders with 20 units or more, please contact Customer Service for pricing.

Minimum Prepaid Freight Charges

Orders with 5 or less chairs (in any combination of guest, swivel, lounge, etc.) will be charged \$195 list per order.

5 | 15

Five Rooms in Fifteen Days

Seating marked with this logo is a part of Taylor's "Five Rooms in Fifteen Days" program. Refer to page 11 for details.

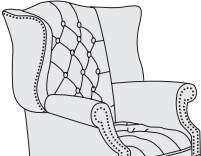
Model	Dimensions	Zone	COM	A	B	C	D	COL	L1	L2	L3	
2831T Chippendale Lounge 	Width	34"	Will Call	2050	2365	2635	2905	3705	2365	2795	3075	3705
	Depth	33"	Zone 1	2240	2555	2825	3095	3895	2555	2985	3265	3895
	Height	42½"	Zone 2	2275	2590	2860	3130	3930	2590	3020	3300	3930
	Seat Height	18½"	Zone 3	2280	2595	2865	3135	3935	2595	3025	3305	3935
	Seat Depth	20½"	Zone 4	2290	2605	2875	3145	3945	2605	3035	3315	3945
	Arm Height	26"										
	Width/B Arms	21½"										
	COM	8¼ yds.										
	COL	112 sq. ft.										
	Weight	70 lbs.										

Product Notes:

Not available in vinyl upholstery.
Optional welts in lieu of brass nails - add \$150 list, please specify.
Available in **medium and dark Taylor finishes only**.

Hand-Fold Tufted
Seat and Back

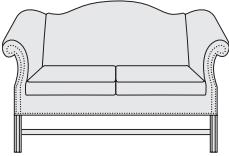
Model	Dimensions	Zone	COM	A	B	C	D	COL	L1	L2	L3	
2860 Chippendale Lounge 	Width	58½"	Will Call	2055	2640	3040	3510	4745	2640	3240	3760	4745
	Depth	33½"	Zone 1	2330	2915	3315	3785	5020	2915	3515	4035	5020
	Height	35"	Zone 2	2360	2945	3345	3815	5050	2945	3545	4065	5050
	Seat Height	17¾"	Zone 3	2370	2955	3355	3825	5060	2955	3555	4075	5060
	Seat Depth	20¼"	Zone 4	2380	2965	3365	3835	5070	2965	3565	4085	5070
	Arm Height	27"										
	Width/B Arms	39"										
	COM	11 yds.										
	COL	150 sq. ft.										
	Weight	91 lbs.										

Product Notes:

Optional welts in lieu of brass nails - add \$150 list, please specify.
Available in **medium and dark Taylor finishes only**.

Loose Cushion Seat

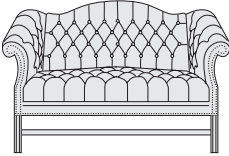
Model	Dimensions	Zone	COM	A	B	C	D	COL	L1	L2	L3	
2860T Chippendale Lounge 	Width	58½"	Will Call	2550	3140	3540	4010	5245	3140	3740	4260	5245
	Depth	33½"	Zone 1	2825	3415	3815	4285	5520	3415	4015	4535	5520
	Height	35"	Zone 2	2855	3445	3845	4315	5550	3445	4045	4565	5550
	Seat Height	17¾"	Zone 3	2865	3455	3855	4325	5560	3455	4055	4575	5560
	Seat Depth	20"	Zone 4	2875	3465	3865	4335	5570	3465	4065	4585	5570
	Arm Height	27"										
	Width/B Arms	39"										
	COM	11½ yds.										
	COL	156 sq. ft.										
	Weight	91 lbs.										

Product Notes:

Not available in vinyl upholstery.
Optional welts in lieu of brass nails - add \$150 list, please specify.
Available in **medium and dark Taylor finishes only**.

Hand-Fold Tufted
Seat and Back

To specify, include:

- Model Number
- Wood Finish
- Fabric | Leather
- Quantity

Wood Finishes

- **RCL** Royal Cherry
- **LWL** Light Walnut
- **ESP** Espresso
- **MHL** Mahogany
- **SMK** Smoke
- **CML** Clear Maple
- **COL** Clear Oak
- **CHY** Cherry
- **AMB** Amber
- **BLK** Black

Graded-In Fabric | Leather

Specific grades for fabrics and leathers can be found on the separate grade cards found in your Taylor binder. For fabric and leather patterns not graded-in, please contact Customer Service for pricing.

Dimensions

Dimensions listed in this price book are in inches and approximate.

Freight

Zone list pricing includes freight prepaid by Taylor for delivery to one destination only within the zone. See pg. 5 for details.

Large Order Freight Discount

For orders with 20 units or more, please contact Customer Service for pricing.

Minimum Prepaid Freight Charges

Orders with **5 or less chairs** (in any combination of guest, swivel, lounge, etc.) will be charged **\$195 list per order**.

5 | 15

Five Rooms in Fifteen Days

Seating marked with this logo is a part of Taylor's "Five Rooms in Fifteen Days" program. Refer to page 11 for details.

Model	Dimensions	Zone	COM	A	B	C	D	COL	L1	L2	L3	
2880 Chippendale Lounge	Width	80"	Will Call	2765	3390	4015	4430	5970	3390	4220	4680	5970
	Depth	33"	Zone 1	3105	3730	4355	4770	6310	3730	4560	5020	6310
	Height	35"	Zone 2	3140	3765	4390	4805	6345	3765	4595	5055	6345
	Seat Height	17¾"	Zone 3	3150	3775	4400	4815	6355	3775	4605	5065	6355
	Seat Depth	20¼"	Zone 4	3160	3785	4410	4825	6365	3785	4615	5075	6365
	Arm Height	27"										
	Width/B Arms	62"										
	COM	14 yds.										
COL	189 sq. ft.											
Weight	130 lbs.											

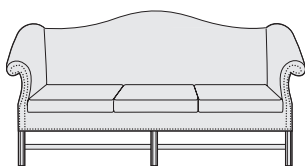

Loose Cushion Seat

Product Notes:

Optional welts in lieu of brass nails - **add \$195 list**, please specify. Available in **medium and dark Taylor finishes only**.

Model	Dimensions	Zone	COM	A	B	C	D	COL	L1	L2	L3	
2880T Chippendale Lounge	Width	80"	Will Call	3310	3935	4560	4975	6515	3935	4765	5225	6515
	Depth	33"	Zone 1	3650	4275	4900	5315	6855	4275	5105	5565	6855
	Height	35"	Zone 2	3685	4310	4935	5350	6890	4310	5140	5600	6890
	Seat Height	17"	Zone 3	3695	4320	4945	5360	6900	4320	5150	5610	6900
	Seat Depth	20¼"	Zone 4	3705	4330	4955	5370	6910	4330	5160	5620	6910
	Arm Height	27"										
	Width/B Arms	62"										
	COM	14½ yds.										
COL	196 sq. ft.											
Weight	130 lbs.											

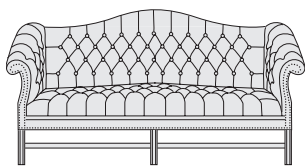

Hand-Fold Tufted Seat and Back

Product Notes:

Not available in vinyl upholstery. Optional welts in lieu of brass nails - **add \$195 list**, please specify. Available in **medium and dark Taylor finishes only**.

Model	Dimensions	Zone	COM	A	B	C	D	COL	L1	L2	L3	
4800.5 Judge	Width	28½"	Will Call	1740	2100	2340	2575	3205	2100	2455	2670	3205
	Depth	31¾"	Zone 1	1930	2290	2530	2765	3395	2290	2645	2860	3395
	Height	46¾" - 50½"	Zone 2	1965	2325	2565	2800	3430	2325	2680	2895	3430
	Seat Height	20¾" - 24½"	Zone 3	1970	2330	2570	2805	3435	2330	2685	2900	3435
	Seat Depth	18½"	Zone 4	1980	2340	2580	2815	3445	2340	2695	2910	3445
	Arm Height	27¾" - 31½"										
	Width/B Arms	21"										
	Standard Base	705										
Alternate Base	1405											
COM	5 yds.											
COL	68 sq. ft.											
Weight	93 lbs.											



High Back, Head Roll

Product Notes:

Mechanical height adjustment and swivel-tilt mechanism. Available in **medium and dark Taylor finishes only**.

TRADITIONAL

To specify, include:

- Model Number
- Wood Finish
- Fabric | Leather
- Quantity

Wood Finishes

- RCL Royal Cherry
- LWL Light Walnut
- ESP Espresso
- MHL Mahogany
- SMK Smoke
- CML Clear Maple
- COL Clear Oak
- CHY Cherry
- AMB Amber
- BLK Black

Graded-In Fabric | Leather

Specific grades for fabrics and leathers can be found on the separate grade cards found in your Taylor binder. For fabric and leather patterns not graded-in, please contact Customer Service for pricing.

Dimensions

Dimensions listed in this price book are in inches and approximate.

Freight

Zone list pricing includes freight prepaid by Taylor for delivery to one destination only within the zone. See pg. 5 for details.

Large Order Freight Discount

For orders with 20 units or more, please contact Customer Service for pricing.

Minimum Prepaid Freight Charges

Orders with **5 or less chairs** (in any combination of guest, swivel, lounge, etc.) will be charged **\$195 list per order**.

5|15

Five Rooms in Fifteen Days

Seating marked with this logo is a part of Taylor's "Five Rooms in Fifteen Days" program. Refer to page 11 for details.

Model	Dimensions	Zone	COM	A	B	C	D	COL	L1	L2	L3	
9810.5RA Arlington	Width	26"	Will Call	1695	1920	2145	2370	3105	1920	2260	2535	3105
	Depth	30"	Zone 1	1825	2050	2275	2500	3235	2050	2390	2665	3235
	Height	37½" - 41¼"	Zone 2	1845	2070	2295	2520	3255	2070	2410	2685	3255
	Seat Height	18½" - 22¼"	Zone 3	1850	2075	2300	2525	3260	2075	2415	2690	3260
	Seat Depth	19"	Zone 4	1860	2085	2310	2535	3270	2085	2425	2700	3270
	Arm Height	25¾" - 29½"	Product Notes:									
	Width/B Arms	21"	Pneumatic height adjustment and knee-tilt mechanism.									
	Standard Base	1405	Optional swivel-tilt mechanism - reduce \$25 list , please specify.									
	Alternate Base	1705, 1805	Optional upholstered button detail on back - add \$50 list .									
	COM	3½ yds.	Please specify (-2B) two buttons; or (-4B) four buttons.									
COL	52 sq. ft.	Alternate polished aluminum base - add \$95 list , please specify (-1805 base).										
Weight	63 lbs.	Available in all Taylor finishes.										



Low Back, Rolled Arms, Attached Cushion

Model	Dimensions	Zone	COM	A	B	C	D	COL	L1	L2	L3	
9810.5UA Arlington	Width	26¼"	Will Call	1695	1920	2145	2370	3105	1920	2260	2535	3105
	Depth	30"	Zone 1	1825	2050	2275	2500	3235	2050	2390	2665	3235
	Height	37½" - 41¼"	Zone 2	1845	2070	2295	2520	3255	2070	2410	2685	3255
	Seat Height	18½" - 22¼"	Zone 3	1850	2075	2300	2525	3260	2075	2415	2690	3260
	Seat Depth	19"	Zone 4	1860	2085	2310	2535	3270	2085	2425	2700	3270
	Arm Height	25¾" - 29½"	Product Notes:									
	Width/B Arms	20¼"	Pneumatic height adjustment and knee-tilt mechanism.									
	Standard Base	1405	Optional swivel-tilt mechanism - reduce \$25 list , please specify.									
	Alternate Base	1705, 1805	Optional upholstered button detail on back - add \$50 list .									
	COM	3½ yds.	Please specify (-2B) two buttons; or (-4B) four buttons.									
COL	52 sq. ft.	Alternate polished aluminum base - add \$95 list , please specify (-1805 base).										
Weight	63 lbs.	Available in all Taylor finishes.										



Low Back, Upholstered Arms, Attached Cushion

Model	Dimensions	Zone	COM	A	B	C	D	COL	L1	L2	L3	
9810.5CA Arlington	Width	26"	Will Call	1695	1920	2145	2370	3105	1920	2260	2535	3105
	Depth	30"	Zone 1	1825	2050	2275	2500	3235	2050	2390	2665	3235
	Height	37½" - 41¼"	Zone 2	1845	2070	2295	2520	3255	2070	2410	2685	3255
	Seat Height	18½" - 22¼"	Zone 3	1850	2075	2300	2525	3260	2075	2415	2690	3260
	Seat Depth	19"	Zone 4	1860	2085	2310	2535	3270	2085	2425	2700	3270
	Arm Height	26" - 29¾"	Product Notes:									
	Width/B Arms	20"	Pneumatic height adjustment and knee-tilt mechanism.									
	Standard Base	1405	Optional swivel-tilt mechanism - reduce \$25 list , please specify.									
	Alternate Base	1705, 1805	Optional upholstered button detail on back - add \$50 list .									
	COM	4¼ yds.	Please specify (-2B) two buttons; or (-4B) four buttons.									
COL	62 sq. ft.	Alternate polished aluminum base - add \$95 list , please specify (-1805 base).										
Weight	68 lbs.	Available in all Taylor finishes.										



Low Back, Closed Arms, Attached Cushion

To specify, include:

- Model Number
- Wood Finish
- Fabric | Leather
- Quantity

Wood Finishes

- RCL Royal Cherry
- LWL Light Walnut
- ESP Espresso
- MHL Mahogany
- SMK Smoke
- CML Clear Maple
- COL Clear Oak
- CHY Cherry
- AMB Amber
- BLK Black

Graded-In Fabric | Leather

Specific grades for fabrics and leathers can be found on the separate grade cards found in your Taylor binder. For fabric and leather patterns not graded-in, please contact Customer Service for pricing.

Dimensions

Dimensions listed in this price book are in inches and approximate.

Freight

Zone list pricing includes freight prepaid by Taylor for delivery to one destination only within the zone. See pg. 5 for details.

Large Order Freight Discount

For orders with 20 units or more, please contact Customer Service for pricing.

Minimum Prepaid Freight Charges

Orders with 5 or less chairs (in any combination of guest, swivel, lounge, etc.) will be charged \$195 list per order.

5|15

Five Rooms in Fifteen Days

Seating marked with this logo is a part of Taylor's "Five Rooms in Fifteen Days" program. Refer to page 11 for details.

Model	Dimensions	Zone	COM	A	B	C	D	COL	L1	L2	L3		
9815.5RA Arlington 	<div style="background-color: #ccc; padding: 5px; display: inline-block;">5 15</div> Width 26" Depth 30" Height 36" - 39¾" Seat Height 18" - 21¾" Seat Depth 20" Arm Height 25½" - 29¼" Width/B Arms 21" Standard Base 1405 Alternate Base 1705, 1805 COM 2¾ yds. COL 38 sq. ft. Weight 66 lbs.	Will Call	1400	1740	1970	2195	2825	1740	2085	2360	2825		
		Zone 1	1530	1870	2100	2325	2955	1870	2215	2490	2955		
		Zone 2	1550	1890	2120	2345	2975	1890	2235	2510	2975		
		Zone 3	1555	1895	2125	2350	2980	1895	2240	2515	2980		
		Zone 4	1565	1905	2135	2360	2990	1905	2250	2525	2990		
		Product Notes:											
		Pneumatic height adjustment and knee-tilt mechanism.											
		Optional swivel-tilt mechanism - reduce \$25 list , please specify.											
		Alternate polished aluminum base - add \$95 list , please specify (-1805 base).											
		Available in all Taylor finishes.											

Low Back,
Rolled Arms

9815.5UA Arlington 	<div style="background-color: #ccc; padding: 5px; display: inline-block;">5 15</div> Width 26¼" Depth 30" Height 36" - 39¾" Seat Height 18" - 21¾" Seat Depth 20" Arm Height 25¾" - 29½" Width/B Arms 20¼" Standard Base 1405 Alternate Base 1705, 1805 COM 2¾ yds. COL 38 sq. ft. Weight 66 lbs.	Will Call	1400	1740	1970	2195	2825	1740	2085	2360	2825		
		Zone 1	1530	1870	2100	2325	2955	1870	2215	2490	2955		
		Zone 2	1550	1890	2120	2345	2975	1890	2235	2510	2975		
		Zone 3	1555	1895	2125	2350	2980	1895	2240	2515	2980		
		Zone 4	1565	1905	2135	2360	2990	1905	2250	2525	2990		
		Product Notes:											
		Pneumatic height adjustment and knee-tilt mechanism.											
		Optional swivel-tilt mechanism - reduce \$25 list , please specify.											
		Alternate polished aluminum base - add \$95 list , please specify (-1805 base).											
		Available in all Taylor finishes.											

Low Back,
Upholstered Arms

9815.5CA Arlington 	<div style="background-color: #ccc; padding: 5px; display: inline-block;">5 15</div> Width 26" Depth 30" Height 36" - 39¾" Seat Height 18" - 21¾" Seat Depth 20" Arm Height 26" - 29¾" Width/B Arms 20" Standard Base 1405 Alternate Base 1705, 1805 COM 3½ yds. COL 48 sq. ft. Weight 68 lbs.	Will Call	1400	1740	1970	2195	2825	1740	2085	2360	2825		
		Zone 1	1530	1870	2100	2325	2955	1870	2215	2490	2955		
		Zone 2	1550	1890	2120	2345	2975	1890	2235	2510	2975		
		Zone 3	1555	1895	2125	2350	2980	1895	2240	2515	2980		
		Zone 4	1565	1905	2135	2360	2990	1905	2250	2525	2990		
		Product Notes:											
		Pneumatic height adjustment and knee-tilt mechanism.											
		Optional swivel-tilt mechanism - reduce \$25 list , please specify.											
		Alternate polished aluminum base - add \$95 list , please specify (-1805 base).											
		Available in all Taylor finishes.											

Low Back,
Closed Arms

TRADITIONAL

To specify, include:

- Model Number
- Wood Finish
- Fabric | Leather
- Quantity

Wood Finishes

- RCL Royal Cherry
- LWL Light Walnut
- ESP Espresso
- MHL Mahogany
- SMK Smoke
- CML Clear Maple
- COL Clear Oak
- CHY Cherry
- AMB Amber
- BLK Black

Graded-In Fabric | Leather

Specific grades for fabrics and leathers can be found on the separate grade cards found in your Taylor binder. For fabric and leather patterns not graded-in, please contact Customer Service for pricing.

Dimensions

Dimensions listed in this price book are in inches and approximate.

Freight

Zone list pricing includes freight prepaid by Taylor for delivery to one destination only within the zone. See pg. 5 for details.

Large Order Freight Discount

For orders with 20 units or more, please contact Customer Service for pricing.

Minimum Prepaid Freight Charges

Orders with **5 or less chairs** (in any combination of guest, swivel, lounge, etc.) will be charged **\$195 list per order**.

5 | 15

Five Rooms in Fifteen Days

Seating marked with this logo is a part of Taylor's "Five Rooms in Fifteen Days" program. Refer to page 11 for details.

Model	Dimensions	Zone	COM	A	B	C	D	COL	L1	L2	L3	
9820.5RA Arlington	Width	26"	Will Call	1745	1975	2205	2420	3155	1975	2320	2590	3155
	Depth	30"	Zone 1	1875	2105	2335	2550	3285	2105	2450	2720	3285
	Height	41½" - 45¼"	Zone 2	1895	2125	2355	2570	3305	2125	2470	2740	3305
	Seat Height	18½" - 22¼"	Zone 3	1900	2130	2360	2575	3310	2130	2475	2745	3310
	Seat Depth	19"	Zone 4	1910	2140	2370	2585	3320	2140	2485	2755	3320
	Arm Height	25½" - 29¼"										
	Width/B Arms	21"										
	Standard Base	1405										
	Alternate Base	1705, 1805										
	COM	4¼ yds.										
COL	62 sq. ft.											
Weight	69 lbs.											

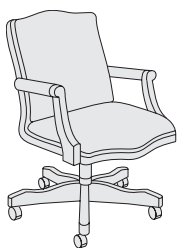

Mid Back, Rolled Arms, Attached Cushion

Product Notes:

Pneumatic height adjustment and knee-tilt mechanism.
 Optional swivel-tilt mechanism - **reduce \$25 list**, please specify.
 Optional upholstered button detail on back - **add \$50 list**.
 Please specify **(-2B)** two buttons; or **(-4B)** four buttons.
 Alternate polished aluminum base - **add \$95 list**, please specify (-1805 base).
 Available in all Taylor finishes.

Model	Dimensions	Zone	COM	A	B	C	D	COL	L1	L2	L3	
9820.5UA Arlington	Width	26¼"	Will Call	1745	1975	2205	2420	3155	1975	2320	2590	3155
	Depth	30"	Zone 1	1875	2105	2335	2550	3285	2105	2450	2720	3285
	Height	41½" - 45¼"	Zone 2	1895	2125	2355	2570	3305	2125	2470	2740	3305
	Seat Height	18½" - 22¼"	Zone 3	1900	2130	2360	2575	3310	2130	2475	2745	3310
	Seat Depth	19"	Zone 4	1910	2140	2370	2585	3320	2140	2485	2755	3320
	Arm Height	25¾" - 29½"										
	Width/B Arms	20¼"										
	Standard Base	1405										
	Alternate Base	1705, 1805										
	COM	4¼ yds.										
COL	62 sq. ft.											
Weight	69 lbs.											

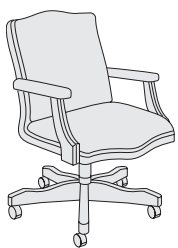

Mid Back, Upholstered Arms, Attached Cushion

Product Notes:

Pneumatic height adjustment and knee-tilt mechanism.
 Optional swivel-tilt mechanism - **reduce \$25 list**, please specify.
 Optional upholstered button detail on back - **add \$50 list**.
 Please specify **(-2B)** two buttons; or **(-4B)** four buttons.
 Alternate polished aluminum base - **add \$95 list**, please specify (-1805 base).
 Available in all Taylor finishes.

Model	Dimensions	Zone	COM	A	B	C	D	COL	L1	L2	L3	
9820.5CA Arlington	Width	26"	Will Call	1745	1975	2205	2420	3155	1975	2320	2590	3155
	Depth	30"	Zone 1	1875	2105	2335	2550	3285	2105	2450	2720	3285
	Height	41½" - 45¼"	Zone 2	1895	2125	2355	2570	3305	2125	2470	2740	3305
	Seat Height	18½" - 22¼"	Zone 3	1900	2130	2360	2575	3310	2130	2475	2745	3310
	Seat Depth	19"	Zone 4	1910	2140	2370	2585	3320	2140	2485	2755	3320
	Arm Height	26" - 29¾"										
	Width/B Arms	20"										
	Standard Base	1405										
	Alternate Base	1705, 1805										
	COM	5 yds.										
COL	70 sq. ft.											
Weight	71 lbs.											



Mid Back, Closed Arms, Attached Cushion

Product Notes:

Pneumatic height adjustment and knee-tilt mechanism.
 Optional swivel-tilt mechanism - **reduce \$25 list**, please specify.
 Optional upholstered button detail on back - **add \$50 list**.
 Please specify **(-2B)** two buttons; or **(-4B)** four buttons.
 Alternate polished aluminum base - **add \$95 list**, please specify (-1805 base).
 Available in all Taylor finishes.

To specify, include:

- Model Number
- Wood Finish
- Fabric | Leather
- Quantity

Wood Finishes

- RCL Royal Cherry
- LWL Light Walnut
- ESP Espresso
- MHL Mahogany
- SMK Smoke
- CML Clear Maple
- COL Clear Oak
- CHY Cherry
- AMB Amber
- BLK Black

Graded-In Fabric | Leather

Specific grades for fabrics and leathers can be found on the separate grade cards found in your Taylor binder. For fabric and leather patterns not graded-in, please contact Customer Service for pricing.

Dimensions

Dimensions listed in this price book are in inches and approximate.

Freight

Zone list pricing includes freight prepaid by Taylor for delivery to one destination only within the zone. See pg. 5 for details.

Large Order Freight Discount

For orders with 20 units or more, please contact Customer Service for pricing.

Minimum Prepaid Freight Charges

Orders with 5 or less chairs (in any combination of guest, swivel, lounge, etc.) will be charged \$195 list per order.

5|15

Five Rooms in Fifteen Days

Seating marked with this logo is a part of Taylor's "Five Rooms in Fifteen Days" program. Refer to page 11 for details.

Model	Dimensions	Zone	COM	A	B	C	D	COL	L1	L2	L3		
9825.5RA Arlington 	<div style="background-color: #ccc; padding: 5px; display: inline-block;">5 15</div> Width 26" Depth 30" Height 40" - 43¾" Seat Height 18½" - 22¼" Seat Depth 20" Arm Height 25½" - 29¼" Width/B Arms 21" Standard Base 1405 Alternate Base 1705, 1805 COM 3 yds. COL 41 sq. ft. Weight 68 lbs.	Will Call	1455	1800	2025	2245	2885	1800	2140	2410	2885		
		Zone 1	1585	1930	2155	2375	3015	1930	2270	2540	3015		
		Zone 2	1605	1950	2175	2395	3035	1950	2290	2560	3035		
		Zone 3	1610	1955	2180	2400	3040	1955	2295	2565	3040		
		Zone 4	1620	1965	2190	2410	3050	1965	2305	2575	3050		
		Product Notes:											
		Pneumatic height adjustment and knee-tilt mechanism.											
		Optional swivel-tilt mechanism - reduce \$25 list , please specify.											
		Alternate polished aluminum base - add \$95 list , please specify (-1805 base).											
		Available in all Taylor finishes.											

Mid Back,
Rolled Arms

9825.5UA Arlington 	<div style="background-color: #ccc; padding: 5px; display: inline-block;">5 15</div> Width 26¼" Depth 30" Height 40" - 43¾" Seat Height 18½" - 22¼" Seat Depth 20" Arm Height 25¾" - 29½" Width/B Arms 20¼" Standard Base 1405 Alternate Base 1705, 1805 COM 3 yds. COL 41 sq. ft. Weight 68 lbs.	Will Call	1455	1800	2025	2245	2885	1800	2140	2410	2885		
		Zone 1	1585	1930	2155	2375	3015	1930	2270	2540	3015		
		Zone 2	1605	1950	2175	2395	3035	1950	2290	2560	3035		
		Zone 3	1610	1955	2180	2400	3040	1955	2295	2565	3040		
		Zone 4	1620	1965	2190	2410	3050	1965	2305	2575	3050		
		Product Notes:											
		Pneumatic height adjustment and knee-tilt mechanism.											
		Optional swivel-tilt mechanism - reduce \$25 list , please specify.											
		Alternate polished aluminum base - add \$95 list , please specify (-1805 base).											
		Available in all Taylor finishes.											

Mid Back,
Upholstered Arms

9825.5CA Arlington 	<div style="background-color: #ccc; padding: 5px; display: inline-block;">5 15</div> Width 26" Depth 30" Height 40" - 43¾" Seat Height 18½" - 22¼" Seat Depth 20" Arm Height 26" - 29¾" Width/B Arms 20" Standard Base 1405 Alternate Base 1705, 1805 COM 3¾ yds. COL 51 sq. ft. Weight 70 lbs.	Will Call	1455	1800	2025	2245	2885	1800	2140	2410	2885		
		Zone 1	1585	1930	2155	2375	3015	1930	2270	2540	3015		
		Zone 2	1605	1950	2175	2395	3035	1950	2290	2560	3035		
		Zone 3	1610	1955	2180	2400	3040	1955	2295	2565	3040		
		Zone 4	1620	1965	2190	2410	3050	1965	2305	2575	3050		
		Product Notes:											
		Pneumatic height adjustment and knee-tilt mechanism.											
		Optional swivel-tilt mechanism - reduce \$25 list , please specify.											
		Alternate polished aluminum base - add \$95 list , please specify (-1805 base).											
		Available in all Taylor finishes.											

Mid Back,
Closed Arms

TRADITIONAL

To specify, include:

- Model Number
- Wood Finish
- Fabric | Leather
- Quantity

Wood Finishes

- RCL Royal Cherry
- LWL Light Walnut
- ESP Espresso
- MHL Mahogany
- SMK Smoke
- CML Clear Maple
- COL Clear Oak
- CHY Cherry
- AMB Amber
- BLK Black

Graded-In Fabric | Leather

Specific grades for fabrics and leathers can be found on the separate grade cards found in your Taylor binder. For fabric and leather patterns not graded-in, please contact Customer Service for pricing.

Dimensions

Dimensions listed in this price book are in inches and approximate.

Freight

Zone list pricing includes freight prepaid by Taylor for delivery to one destination only within the zone. See pg. 5 for details.

Large Order Freight Discount

For orders with 20 units or more, please contact Customer Service for pricing.

Minimum Prepaid Freight Charges

Orders with **5 or less chairs** (in any combination of guest, swivel, lounge, etc.) will be charged **\$195 list per order**.

5|15

Five Rooms in Fifteen Days

Seating marked with this logo is a part of Taylor's "Five Rooms in Fifteen Days" program. Refer to page 11 for details.

Model	Dimensions	Zone	COM	A	B	C	D	COL	L1	L2	L3	
9830.5RA Arlington 	Width	26"	Will Call	1850	2080	2310	2525	3330	2080	2420	2695	3330
	Depth	31"	Zone 1	1980	2210	2440	2655	3460	2210	2550	2825	3460
	Height	45" - 48¾"	Zone 2	2000	2230	2460	2675	3480	2230	2570	2845	3480
	Seat Height	18½" - 22¼"	Zone 3	2005	2235	2465	2680	3485	2235	2575	2850	3485
	Seat Depth	19"	Zone 4	2015	2245	2475	2690	3495	2245	2585	2860	3495
	Arm Height	25½" - 29¼"	Product Notes:									
	Width/B Arms	21"	Pneumatic height adjustment and knee-tilt mechanism.									
	Standard Base	1405	Optional swivel-tilt mechanism - reduce \$25 list , please specify.									
	Alternate Base	1705, 1805	Optional upholstered button detail on back - add \$50 list .									
	COM	4¾ yds.	Please specify (-6B) six buttons.									
COL	68 sq. ft.	Alternate polished aluminum base - add \$95 list , please specify (-1805 base).										
Weight	72 lbs.	Available in all Taylor finishes.										

High Back, Rolled Arms, Attached Cushion

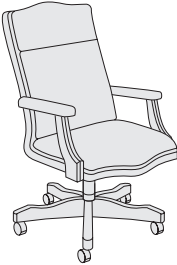
Model	Dimensions	Zone	COM	A	B	C	D	COL	L1	L2	L3	
9830.5UA Arlington 	Width	26¼"	Will Call	1850	2080	2310	2525	3330	2080	2420	2695	3330
	Depth	31"	Zone 1	1980	2210	2440	2655	3460	2210	2550	2825	3460
	Height	45" - 48¾"	Zone 2	2000	2230	2460	2675	3480	2230	2570	2845	3480
	Seat Height	18½" - 22¼"	Zone 3	2005	2235	2465	2680	3485	2235	2575	2850	3485
	Seat Depth	19"	Zone 4	2015	2245	2475	2690	3495	2245	2585	2860	3495
	Arm Height	25¾" - 29½"	Product Notes:									
	Width/B Arms	20¼"	Pneumatic height adjustment and knee-tilt mechanism.									
	Standard Base	1405	Optional swivel-tilt mechanism - reduce \$25 list , please specify.									
	Alternate Base	1705, 1805	Optional upholstered button detail on back - add \$50 list .									
	COM	4¾ yds.	Please specify (-6B) six buttons.									
COL	68 sq. ft.	Alternate polished aluminum base - add \$95 list , please specify (-1805 base).										
Weight	72 lbs.	Available in all Taylor finishes.										

High Back, Upholstered Arms, Attached Cushion

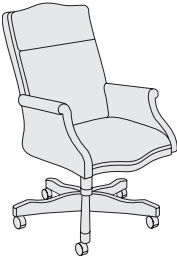
Model	Dimensions	Zone	COM	A	B	C	D	COL	L1	L2	L3	
9830.5CA Arlington 	Width	26"	Will Call	1850	2080	2310	2525	3330	2080	2420	2695	3330
	Depth	31"	Zone 1	1980	2210	2440	2655	3460	2210	2550	2825	3460
	Height	45" - 48¾"	Zone 2	2000	2230	2460	2675	3480	2230	2570	2845	3480
	Seat Height	18½" - 22¼"	Zone 3	2005	2235	2465	2680	3485	2235	2575	2850	3485
	Seat Depth	19"	Zone 4	2015	2245	2475	2690	3495	2245	2585	2860	3495
	Arm Height	26" - 29¾"	Product Notes:									
	Width/B Arms	20"	Pneumatic height adjustment and knee-tilt mechanism.									
	Standard Base	1405	Optional swivel-tilt mechanism - reduce \$25 list , please specify.									
	Alternate Base	1705, 1805	Optional upholstered button detail on back - add \$50 list .									
	COM	5¼ yds.	Please specify (-6B) six buttons.									
COL	77 sq. ft.	Alternate polished aluminum base - add \$95 list , please specify (-1805 base).										
Weight	74 lbs.	Available in all Taylor finishes.										

High Back, Closed Arms, Attached Cushion

To specify, include:

- Model Number
- Wood Finish
- Fabric | Leather
- Quantity

Wood Finishes

- RCL Royal Cherry
- LWL Light Walnut
- ESP Espresso
- MHL Mahogany
- SMK Smoke
- CML Clear Maple
- COL Clear Oak
- CHY Cherry
- AMB Amber
- BLK Black

Graded-In Fabric | Leather

Specific grades for fabrics and leathers can be found on the separate grade cards found in your Taylor binder. For fabric and leather patterns not graded-in, please contact Customer Service for pricing.

Dimensions

Dimensions listed in this price book are in inches and approximate.

Freight

Zone list pricing includes freight prepaid by Taylor for delivery to one destination only within the zone. See pg. 5 for details.

Large Order Freight Discount

For orders with 20 units or more, please contact Customer Service for pricing.

Minimum Prepaid Freight Charges

Orders with 5 or less chairs (in any combination of guest, swivel, lounge, etc.) will be charged \$195 list per order.

5|15

Five Rooms in Fifteen Days

Seating marked with this logo is a part of Taylor's "Five Rooms in Fifteen Days" program. Refer to page 11 for details.

Model	Dimensions	Zone	COM	A	B	C	D	COL	L1	L2	L3		
9835.5RA Arlington 	<div style="background-color: #ccc; padding: 5px; display: inline-block;">5 15</div> Width 26" Depth 31" Height 44" - 47¾" Seat Height 18" - 21¾" Seat Depth 20" Arm Height 25½" - 29¼" Width/B Arms 21" Standard Base 1405 Alternate Base 1705, 1805 COM 3½ yds. COL 48 sq. ft. Weight 70 lbs.	Will Call	1575	1885	2095	2305	3010	1885	2200	2510	3010		
		Zone 1	1705	2015	2225	2435	3140	2015	2330	2640	3140		
		Zone 2	1725	2035	2245	2455	3160	2035	2350	2660	3160		
		Zone 3	1730	2040	2250	2460	3165	2040	2355	2665	3165		
		Zone 4	1740	2050	2260	2470	3175	2050	2365	2675	3175		
		Product Notes:											
		Pneumatic height adjustment and knee-tilt mechanism.											
		Optional swivel-tilt mechanism - reduce \$25 list , please specify.											
		Alternate polished aluminum base - add \$95 list , please specify (-1805 base).											
		Available in all Taylor finishes.											
High Back, Rolled Arms													

9835.5UA Arlington 	<div style="background-color: #ccc; padding: 5px; display: inline-block;">5 15</div> Width 26¼" Depth 31" Height 44" - 47¾" Seat Height 18" - 21¾" Seat Depth 20" Arm Height 25¾" - 29½" Width/B Arms 20¼" Standard Base 1405 Alternate Base 1705, 1805 COM 3½ yds. COL 48 sq. ft. Weight 70 lbs.	Zone	COM	A	B	C	D	COL	L1	L2	L3		
		Will Call	1575	1885	2095	2305	3010	1885	2200	2510	3010		
		Zone 1	1705	2015	2225	2435	3140	2015	2330	2640	3140		
		Zone 2	1725	2035	2245	2455	3160	2035	2350	2660	3160		
		Zone 3	1730	2040	2250	2460	3165	2040	2355	2665	3165		
		Zone 4	1740	2050	2260	2470	3175	2050	2365	2675	3175		
		Product Notes:											
		Pneumatic height adjustment and knee-tilt mechanism.											
		Optional swivel-tilt mechanism - reduce \$25 list , please specify.											
		Alternate polished aluminum base - add \$95 list , please specify (-1805 base).											
Available in all Taylor finishes.													
High Back, Upholstered Arms													

9835.5CA Arlington 	<div style="background-color: #ccc; padding: 5px; display: inline-block;">5 15</div> Width 26" Depth 31" Height 44" - 47¾" Seat Height 18" - 21¾" Seat Depth 20" Arm Height 26" - 29¾" Width/B Arms 19½" Standard Base 1405 Alternate Base 1705, 1805 COM 4¼ yds. COL 58 sq. ft. Weight 72 lbs.	Zone	COM	A	B	C	D	COL	L1	L2	L3		
		Will Call	1575	1885	2095	2305	3010	1885	2200	2510	3010		
		Zone 1	1705	2015	2225	2435	3140	2015	2330	2640	3140		
		Zone 2	1725	2035	2245	2455	3160	2035	2350	2660	3160		
		Zone 3	1730	2040	2250	2460	3165	2040	2355	2665	3165		
		Zone 4	1740	2050	2260	2470	3175	2050	2365	2675	3175		
		Product Notes:											
		Pneumatic height adjustment and knee-tilt mechanism.											
		Optional swivel-tilt mechanism - reduce \$25 list , please specify.											
		Alternate polished aluminum base - add \$95 list , please specify (-1805 base).											
Available in all Taylor finishes.													
High Back, Closed Arms													

TRADITIONAL

To specify, include:

- Model Number
- Wood Finish
- Fabric | Leather
- Quantity

Wood Finishes

- RCL Royal Cherry
- LWL Light Walnut
- ESP Espresso
- MHL Mahogany
- SMK Smoke
- CML Clear Maple
- COL Clear Oak
- CHY Cherry
- AMB Amber
- BLK Black

Graded-In Fabric | Leather

Specific grades for fabrics and leathers can be found on the separate grade cards found in your Taylor binder. For fabric and leather patterns not graded-in, please contact Customer Service for pricing.

Dimensions

Dimensions listed in this price book are in inches and approximate.

Freight

Zone list pricing includes freight prepaid by Taylor for delivery to one destination only within the zone. See pg. 5 for details.

Large Order Freight Discount

For orders with 20 units or more, please contact Customer Service for pricing.

Minimum Prepaid Freight Charges

Orders with 5 or less chairs (in any combination of guest, swivel, lounge, etc.) will be charged \$195 list per order.

5 | 15

Five Rooms in Fifteen Days

Seating marked with this logo is a part of Taylor's "Five Rooms in Fifteen Days" program. Refer to page 11 for details.

Model	Dimensions	Zone	COM	A	B	C	D	COL	L1	L2	L3	
2329 Lexi	Width	28"	Will Call	1060	1590	1945	2275	3040	1590	2120	2440	3040
	Depth	28½"	Zone 1	1250	1780	2135	2465	3230	1780	2310	2630	3230
	Height	29½"	Zone 2	1285	1815	2170	2500	3265	1815	2345	2665	3265
	Seat Height	18¼"	Zone 3	1290	1820	2175	2505	3270	1820	2350	2670	3270
	Seat Depth	20"	Zone 4	1300	1830	2185	2515	3280	1830	2360	2680	3280
	Arm Height	24¼"										
	Width/B Arms	21"										
	COM	4 yds.										
	COL	55 sq. ft.										
	Weight	57 lbs.										

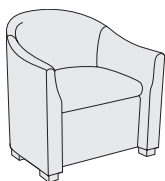

Wood Leg



Product Notes:

Optional casters in lieu of wood legs, please specify (-CAS). Available in all Taylor finishes.

Model	Dimensions	Zone	COM	A	B	C	D	COL	L1	L2	L3	
2359 Lexi	Width	59"	Will Call	1845	2530	2990	3455	4570	2530	3220	3715	4570
	Depth	31½"	Zone 1	2120	2805	3265	3730	4845	2805	3495	3990	4845
	Height	29½"	Zone 2	2150	2835	3295	3760	4875	2835	3525	4020	4875
	Seat Height	18"	Zone 3	2160	2845	3305	3770	4885	2845	3535	4030	4885
	Seat Depth	20½"	Zone 4	2170	2855	3315	3780	4895	2855	3545	4040	4895
	Arm Height	24¼"										
	Width/B Arms	52"										
	COM	7¼ yds.										
	COL	99 sq. ft.										
	Weight	96 lbs.										

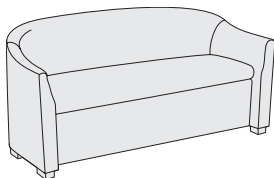

Wood Leg

Product Notes:

Available in all Taylor finishes.

Model	Dimensions	Zone	COM	A	B	C	D	COL	L1	L2	L3	
2429 Lydia	Width	29"	Will Call	1165	1695	2050	2380	3145	1695	2225	2540	3145
	Depth	28¼"	Zone 1	1355	1885	2240	2570	3335	1885	2415	2730	3335
	Height	29"	Zone 2	1390	1920	2275	2605	3370	1920	2450	2765	3370
	Seat Height	18¾"	Zone 3	1395	1925	2280	2610	3375	1925	2455	2770	3375
	Seat Depth	18¼"	Zone 4	1405	1935	2290	2620	3385	1935	2465	2780	3385
	Arm Height	24½"										
	Width/B Arms	20½"										
	COM	6 yds.										
	COL	81 sq. ft.										
	Weight	53 lbs.										

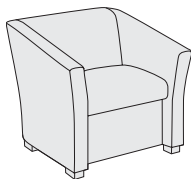

Wood Leg



Product Notes:

Optional casters in lieu of wood legs, please specify (-CAS). Available in all Taylor finishes.

To specify, include:

- Model Number
- Wood Finish
- Fabric | Leather
- Quantity

Wood Finishes

- RCL Royal Cherry
- LWL Light Walnut
- ESP Espresso
- MHL Mahogany
- SMK Smoke
- CML Clear Maple
- COL Clear Oak
- CHY Cherry
- AMB Amber
- BLK Black

Graded-In Fabric | Leather

Specific grades for fabrics and leathers can be found on the separate grade cards found in your Taylor binder. For fabric and leather patterns not graded-in, please contact Customer Service for pricing.

Dimensions

Dimensions listed in this price book are in inches and approximate.

Freight

Zone list pricing includes freight prepaid by Taylor for delivery to one destination only within the zone. See pg. 5 for details.

Large Order Freight Discount

For orders with 20 units or more, please contact Customer Service for pricing.

Minimum Prepaid Freight Charges

Orders with 5 or less chairs (in any combination of guest, swivel, lounge, etc.) will be charged \$195 list per order.

5 | 15

Five Rooms in Fifteen Days

Seating marked with this logo is a part of Taylor's "Five Rooms in Fifteen Days" program. Refer to page 11 for details.

Model	Dimensions	Zone	COM	A	B	C	D	COL	L1	L2	L3	
2459 Lydia	Width	59"	Will Call	1950	2635	3095	3560	4675	2635	3320	3820	4675
	Depth	28¼"	Zone 1	2225	2910	3370	3835	4950	2910	3595	4095	4950
	Height	29"	Zone 2	2255	2940	3400	3865	4980	2940	3625	4125	4980
	Seat Height	18¾"	Zone 3	2265	2950	3410	3875	4990	2950	3635	4135	4990
	Seat Depth	18¼"	Zone 4	2275	2960	3420	3885	5000	2960	3645	4145	5000
	Arm Height	24½"										
	Width/B Arms	51"										
	COM	8½ yds.										
	COL	115 sq. ft.										
	Weight	94 lbs.										

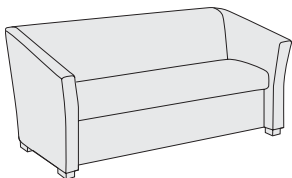

Wood Leg

Product Notes:

Available in all Taylor finishes.

Model	Dimensions	Zone	COM	A	B	C	D	COL	L1	L2	L3	
2520 Hampton	Width	22"	Will Call	620	770	870	970	1175	770	920	1020	1175
	Depth	22"	Zone 1	705	855	955	1055	1260	855	1005	1105	1260
	Height	19½"	Zone 2	715	865	965	1065	1270	865	1015	1115	1270
	COM	2¼ yds.	Zone 3	720	870	970	1070	1275	870	1020	1120	1275
	COL	30 sq. ft.	Zone 4	730	880	980	1080	1285	880	1030	1130	1285
	Weight	28 lbs.										

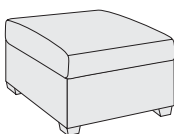

Ottoman,
Fully Upholstered

Product Notes:

Optional square tufting on seat - add \$40 list, please specify (-T). Available in all Taylor finishes.

Model	Dimensions	Zone	COM	A	B	C	D	COL	L1	L2	L3	
2530 Hampton	Width	31"	Will Call	1520	1975	2275	2575	3375	1975	2420	2775	3375
	Depth	33"	Zone 1	1710	2165	2465	2765	3565	2165	2610	2965	3565
	Height	32½"	Zone 2	1745	2200	2500	2800	3600	2200	2645	3000	3600
	Seat Height	19"	Zone 3	1750	2205	2505	2805	3605	2205	2650	3005	3605
	Seat Depth	22¼"	Zone 4	1760	2215	2515	2815	3615	2215	2660	3015	3615
	Arm Height	25"										
	Width/B Arms	22"										
	COM	6¾ yds.										
	COL	91 sq. ft.										
	Weight	80 lbs.										

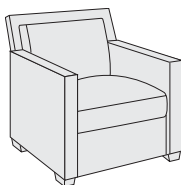

Fully Upholstered

5 | 15

Two-Tone COM/COL*

- COM (Inside Back & Seat Cushion) 2¼ yds.
- COM (Outside Back, Arms, Front Panel) 4½ yds.
- COL (Inside Back & Seat Cushion) 31 sq. ft.
- COL (Outside Back, Arms, Front Panel) 61 sq. ft.

Product Notes:

Optional square tufting on outside arms - add \$50 list, please specify (-TOA).
Optional square tufting on inside back & seat - add \$75 list, please specify (-TBS).
Available in all Taylor finishes.

*Two-tone upholstery applications will be priced at the higher of the two price grades. If two fabrics from the same price grade are used, item will be priced at the next higher price grade. If two COMs are used, item will be priced at the COL price grade.

LOUNGE & MULTIPLE

To specify, include:

- Model Number
- Wood Finish
- Fabric | Leather
- Quantity

Wood Finishes

- RCL Royal Cherry
- LWL Light Walnut
- ESP Espresso
- MHL Mahogany
- SMK Smoke
- CML Clear Maple
- COL Clear Oak
- CHY Cherry
- AMB Amber
- BLK Black

Graded-In Fabric | Leather

Specific grades for fabrics and leathers can be found on the separate grade cards found in your Taylor binder. For fabric and leather patterns not graded-in, please contact Customer Service for pricing.

Dimensions

Dimensions listed in this price book are in inches and approximate.

Freight

Zone list pricing includes freight prepaid by Taylor for delivery to one destination only within the zone. See pg. 5 for details.

Large Order Freight Discount

For orders with 20 units or more, please contact Customer Service for pricing.

Minimum Prepaid Freight Charges

Orders with **5 or less chairs** (in any combination of guest, swivel, lounge, etc.) will be charged **\$195 list per order**.

5 | 15

Five Rooms in Fifteen Days

Seating marked with this logo is a part of Taylor's "Five Rooms in Fifteen Days" program. Refer to page 11 for details.

Model	Dimensions	Zone	COM	A	B	C	D	COL	L1	L2	L3	
2530C Hampton	Width	31"	Will Call	1575	2025	2325	2625	3425	2025	2475	2825	3425
	Depth	33"	Zone 1	1765	2215	2515	2815	3615	2215	2665	3015	3615
	Height	32½"	Zone 2	1800	2250	2550	2850	3650	2250	2700	3050	3650
	Seat Height	19"	Zone 3	1805	2255	2555	2855	3655	2255	2705	3055	3655
	Seat Depth	22¼"	Zone 4	1815	2265	2565	2865	3665	2265	2715	3065	3665
	Arm Height	25"										
	Width/B Arms	22"										
	COM	6¾ yds.										
	COL	91 sq. ft.										
	Weight	80 lbs.										

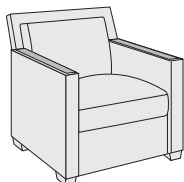

Upholstered with Wood Arm Cap

Two-Tone COM/COL*

- COM (Inside Back & Seat Cushion) 2¼ yds.
- COM (Outside Back, Arms, Front Panel) 4½ yds.
- COL (Inside Back & Seat Cushion) 31 sq. ft.
- COL (Outside Back, Arms, Front Panel) 61 sq. ft.

Product Notes:

Optional square tufting on outside arms - **add \$50 list**, please specify (-TOA).
Optional square tufting on inside back & seat - **add \$75 list**, please specify (-TBS).
Available in all Taylor finishes.

***Two-tone upholstery applications will be priced at the higher of the two price grades.** If two fabrics from the same price grade are used, item will be priced at the next higher price grade. If two COMs are used, item will be priced at the COL price grade.

Model	Dimensions	Zone	COM	A	B	C	D	COL	L1	L2	L3	
2530W Hampton	Width	31"	Will Call	1575	2025	2325	2625	3425	2025	2475	2825	3425
	Depth	33"	Zone 1	1765	2215	2515	2815	3615	2215	2665	3015	3615
	Height	32½"	Zone 2	1800	2250	2550	2850	3650	2250	2700	3050	3650
	Seat Height	19"	Zone 3	1805	2255	2555	2855	3655	2255	2705	3055	3655
	Seat Depth	22¼"	Zone 4	1815	2265	2565	2865	3665	2265	2715	3065	3665
	Arm Height	25"										
	Width/B Arms	22"										
	COM	6¾ yds.										
	COL	91 sq. ft.										
	Weight	80 lbs.										

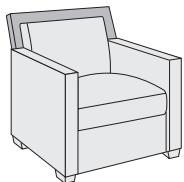

Upholstered with Wood Trim on Back

Two-Tone COM/COL*

- COM (Inside Back & Seat Cushion) 2¼ yds.
- COM (Outside Back, Arms, Front Panel) 4½ yds.
- COL (Inside Back & Seat Cushion) 31 sq. ft.
- COL (Outside Back, Arms, Front Panel) 61 sq. ft.

Product Notes:

Optional wood arm cap - **add \$60 list**, please specify (-C).
Optional square tufting on outside arms - **add \$50 list**, please specify (-TOA).
Optional square tufting on inside back & seat - **add \$75 list**, please specify (-TBS).
Available in all Taylor finishes.

***Two-tone upholstery applications will be priced at the higher of the two price grades.** If two fabrics from the same price grade are used, item will be priced at the next higher price grade. If two COMs are used, item will be priced at the COL price grade.

Model	Dimensions	Zone	COM	A	B	C	D	COL	L1	L2	L3	
2530T Hampton	Width	31½"	Will Call	1620	2075	2375	2725	3475	2075	2570	2875	3475
	Depth	33"	Zone 1	1810	2265	2565	2915	3665	2265	2760	3065	3665
	Height	32½"	Zone 2	1845	2300	2600	2950	3700	2300	2795	3100	3700
	Seat Height	19¼"	Zone 3	1850	2305	2605	2955	3705	2305	2800	3105	3705
	Seat Depth	21½"	Zone 4	1860	2315	2615	2965	3715	2315	2810	3115	3715
	Arm Height	25¾"										
	Width/B Arms	22"										
	COM	6¾ yds.										
	COL	91 sq. ft.										
	Weight	80 lbs.										

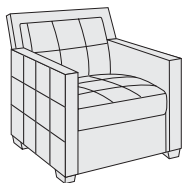

Upholstered with Square Tufting

Two-Tone COM/COL*

- COM (Inside Back & Seat Cushion) 2¼ yds.
- COM (Outside Back, Arms, Front Panel) 4½ yds.
- COL (Inside Back & Seat Cushion) 31 sq. ft.
- COL (Outside Back, Arms, Front Panel) 61 sq. ft.

Product Notes:

Optional wood arm cap - **add \$60 list**, please specify (-C).
Optional wood trim on back - **add \$60 list**, please specify (-W).
Available in all Taylor finishes.

***Two-tone upholstery applications will be priced at the higher of the two price grades.** If two fabrics from the same price grade are used, item will be priced at the next higher price grade. If two COMs are used, item will be priced at the COL price grade.

To specify, include:

- Model Number
- Wood Finish
- Fabric | Leather
- Quantity

Wood Finishes

- RCL Royal Cherry
- LWL Light Walnut
- ESP Espresso
- MHL Mahogany
- SMK Smoke
- CML Clear Maple
- COL Clear Oak
- CHY Cherry
- AMB Amber
- BLK Black

Graded-In Fabric | Leather

Specific grades for fabrics and leathers can be found on the separate grade cards found in your Taylor binder. For fabric and leather patterns not graded-in, please contact Customer Service for pricing.

Dimensions

Dimensions listed in this price book are in inches and approximate.

Freight

Zone list pricing includes freight prepaid by Taylor for delivery to one destination only within the zone. See pg. 5 for details.

Large Order Freight Discount

For orders with 20 units or more, please contact Customer Service for pricing.

Minimum Prepaid Freight Charges

Orders with 5 or less chairs (in any combination of guest, swivel, lounge, etc.) will be charged \$195 list per order.

5 | 15

Five Rooms in Fifteen Days

Seating marked with this logo is a part of Taylor's "Five Rooms in Fifteen Days" program. Refer to page 11 for details.

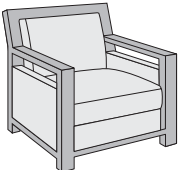
Model	Dimensions	Zone	COM	A	B	C	D	COL	L1	L2	L3	
2531 Hampton	Width	31"	Will Call	1620	2075	2375	2725	3475	2075	2570	2875	3475
	Depth	33"	Zone 1	1810	2265	2565	2915	3665	2265	2760	3065	3665
	Height	32"	Zone 2	1845	2300	2600	2950	3700	2300	2795	3100	3700
	Seat Height	19"	Zone 3	1850	2305	2605	2955	3705	2305	2800	3105	3705
	Seat Depth	22¼"	Zone 4	1860	2315	2615	2965	3715	2315	2810	3115	3715
	Arm Height	25"										
	Width/B Arms	22¾"										
	COM	5¼ yds.										
	COL	72 sq. ft.										
	Weight	76 lbs.										
												

Beveled Wood Arm and Wood Trim on Back

Two-Tone COM/COL*
 COM (Inside Back & Seat Cushion) 2¼ yds.
 COM (Outside Back, Arms, Front Panel) 3 yds.
 COL (Inside Back & Seat Cushion) 31 sq. ft.
 COL (Outside Back, Arms, Front Panel) 41 sq. ft.

Product Notes:
 Optional square tufting on inside back & seat - **add \$75 list**, please specify (-TBS). Available in all Taylor finishes.

***Two-tone upholstery applications will be priced at the higher of the two price grades.** If two fabrics from the same price grade are used, item will be priced at the next higher price grade. If two COMs are used, item will be priced at the COL price grade.

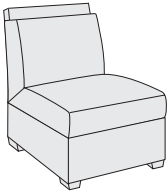
Model	Dimensions	Zone	COM	A	B	C	D	COL	L1	L2	L3	
2532 Hampton	Width	22"	Will Call	1020	1250	1400	1550	1825	1250	1475	1625	1825
	Depth	31"	Zone 1	1210	1440	1590	1740	2015	1440	1665	1815	2015
	Height	32"	Zone 2	1245	1475	1625	1775	2050	1475	1700	1850	2050
	Seat Height	19"	Zone 3	1250	1480	1630	1780	2055	1480	1705	1855	2055
	Seat Depth	22¼"	Zone 4	1260	1490	1640	1790	2065	1490	1715	1865	2065
	COM	4¼ yds.										
	COL	58 sq. ft.										
	Weight	60 lbs.										
												

Armless, Fully Upholstered

Product Notes:
 Optional square tufting on inside back & seat - **add \$75 list**, please specify (-TBS). Available in all Taylor finishes.

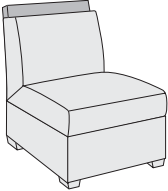
Model	Dimensions	Zone	COM	A	B	C	D	COL	L1	L2	L3	
2532W Hampton	Width	22"	Will Call	1070	1300	1450	1600	1875	1300	1525	1675	1875
	Depth	31"	Zone 1	1260	1490	1640	1790	2065	1490	1715	1865	2065
	Height	32"	Zone 2	1295	1525	1675	1825	2100	1525	1750	1900	2100
	Seat Height	19"	Zone 3	1300	1530	1680	1830	2105	1530	1755	1905	2105
	Seat Depth	22¼"	Zone 4	1310	1540	1690	1840	2115	1540	1765	1915	2115
	COM	4¼ yds.										
	COL	58 sq. ft.										
	Weight	60 lbs.										
												

Armless, Upholstered with Wood Trim on Back

Product Notes:
 Optional square tufting on inside back & seat - **add \$75 list**, please specify (-TBS). Available in all Taylor finishes.

LOUNGE & MULTIPLE

To specify, include:

- Model Number
- Wood Finish
- Fabric | Leather
- Quantity

Wood Finishes

- RCL Royal Cherry
- LWL Light Walnut
- ESP Espresso
- MHL Mahogany
- SMK Smoke
- CML Clear Maple
- COL Clear Oak
- CHY Cherry
- AMB Amber
- BLK Black

Graded-In Fabric | Leather

Specific grades for fabrics and leathers can be found on the separate grade cards found in your Taylor binder. For fabric and leather patterns not graded-in, please contact Customer Service for pricing.

Dimensions

Dimensions listed in this price book are in inches and approximate.

Freight

Zone list pricing includes freight prepaid by Taylor for delivery to one destination only within the zone. See pg. 5 for details.

Large Order Freight Discount

For orders with 20 units or more, please contact Customer Service for pricing.

Minimum Prepaid Freight Charges

Orders with 5 or less chairs (in any combination of guest, swivel, lounge, etc.) will be charged \$195 list per order.

5 | 15

Five Rooms in Fifteen Days

Seating marked with this logo is a part of Taylor's "Five Rooms in Fifteen Days" program. Refer to page 11 for details.

Model	Dimensions	Zone	COM	A	B	C	D	COL	L1	L2	L3	
2550 Hampton	Width	49"	Will Call	1120	1420	1620	1820	2120	1420	1720	1920	2120
	Depth	22"	Zone 1	1310	1610	1810	2010	2310	1610	1910	2110	2310
	Height	19½"	Zone 2	1345	1645	1845	2045	2345	1645	1945	2145	2345
	COM	4¼ yds.	Zone 3	1350	1650	1850	2050	2350	1650	1950	2150	2350
	COL	58 sq. ft.	Zone 4	1360	1660	1860	2060	2360	1660	1960	2160	2360
	Weight	46 lbs.										

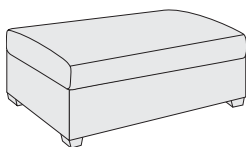

Bench,
Fully Upholstered

Product Notes:

Optional square tufting on seat - **add \$75 list**, please specify (-T). Available in all Taylor finishes.

Model	Dimensions	Zone	COM	A	B	C	D	COL	L1	L2	L3	
2554 Hampton	Width	52"	Will Call	2020	2620	3020	3520	4600	2620	3320	3720	4600
	Depth	33"	Zone 1	2295	2895	3295	3795	4875	2895	3595	3995	4875
	Height	32½"	Zone 2	2325	2925	3325	3825	4905	2925	3625	4025	4905
	Seat Height	19"	Zone 3	2335	2935	3335	3835	4915	2935	3635	4035	4915
	Seat Depth	22¼"	Zone 4	2345	2945	3345	3845	4925	2945	3645	4045	4925
	Arm Height	25"										
	Width/B Arms	43"										
	COM	9½ yds.										
	COL	129 sq. ft.										
	Weight	118 lbs.										

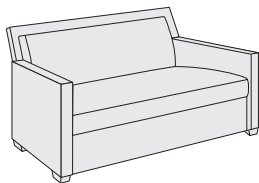

Fully Upholstered

Two-Tone COM/COL*

- COM (Inside Back & Seat Cushion) 3¾ yds.
- COM (Outside Back, Arms, Front Panel) 5¾ yds.
- COL (Inside Back & Seat Cushion) 51 sq. ft.
- COL (Outside Back, Arms, Front Panel) 78 sq. ft.

Product Notes:

Optional square tufting on outside arms - **add \$50 list**, please specify (-TOA).
Optional square tufting on inside back & seat - **add \$150 list**, please specify (-TBS). Available in all Taylor finishes.

*Two-tone upholstery applications will be priced at the higher of the two price grades. If two fabrics from the same price grade are used, item will be priced at the next higher price grade. If two COMs are used, item will be priced at the COL price grade.

Model	Dimensions	Zone	COM	A	B	C	D	COL	L1	L2	L3	
2554C Hampton	Width	52"	Will Call	2075	2675	3075	3575	4650	2675	3375	3775	4650
	Depth	33"	Zone 1	2350	2950	3350	3850	4925	2950	3650	4050	4925
	Height	32½"	Zone 2	2380	2980	3380	3880	4955	2980	3680	4080	4955
	Seat Height	19"	Zone 3	2390	2990	3390	3890	4965	2990	3690	4090	4965
	Seat Depth	22¼"	Zone 4	2400	3000	3400	3900	4975	3000	3700	4100	4975
	Arm Height	25"										
Width/B Arms	43"											
COM	9½ yds.											
COL	129 sq. ft.											
Weight	118 lbs.											

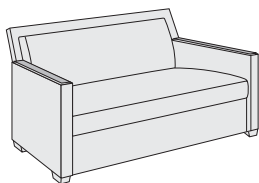

Upholstered with
Wood Arm Cap

Two-Tone COM/COL*

- COM (Inside Back & Seat Cushion) 3¾ yds.
- COM (Outside Back, Arms, Front Panel) 5¾ yds.
- COL (Inside Back & Seat Cushion) 51 sq. ft.
- COL (Outside Back, Arms, Front Panel) 78 sq. ft.

Product Notes:

Optional square tufting on outside arms - **add \$50 list**, please specify (-TOA).
Optional square tufting on inside back & seat - **add \$150 list**, please specify (-TBS). Available in all Taylor finishes.

*Two-tone upholstery applications will be priced at the higher of the two price grades. If two fabrics from the same price grade are used, item will be priced at the next higher price grade. If two COMs are used, item will be priced at the COL price grade.

To specify, include:

- Model Number
- Wood Finish
- Fabric | Leather
- Quantity

Wood Finishes

- **RCL** Royal Cherry
- **LWL** Light Walnut
- **ESP** Espresso
- **MHL** Mahogany
- **SMK** Smoke
- **CML** Clear Maple
- **COL** Clear Oak
- **CHY** Cherry
- **AMB** Amber
- **BLK** Black

Graded-In Fabric | Leather

Specific grades for fabrics and leathers can be found on the separate grade cards found in your Taylor binder. For fabric and leather patterns not graded-in, please contact Customer Service for pricing.

Dimensions

Dimensions listed in this price book are in inches and approximate.

Freight

Zone list pricing includes freight prepaid by Taylor for delivery to one destination only within the zone. See pg. 5 for details.

Large Order Freight Discount

For orders with 20 units or more, please contact Customer Service for pricing.

Minimum Prepaid Freight Charges

Orders with **5 or less chairs** (in any combination of guest, swivel, lounge, etc.) will be charged **\$195 list per order**.

5 | 15

Five Rooms in Fifteen Days

Seating marked with this logo is a part of Taylor's "Five Rooms in Fifteen Days" program. Refer to page 11 for details.

Model	Dimensions	Zone	COM	A	B	C	D	COL	L1	L2	L3	
2554W Hampton	Width	52"	Will Call	2120	2720	3120	3620	4700	2720	3420	3820	4700
	Depth	33"	Zone 1	2395	2995	3395	3895	4975	2995	3695	4095	4975
	Height	32½"	Zone 2	2425	3025	3425	3925	5005	3025	3725	4125	5005
	Seat Height	19"	Zone 3	2435	3035	3435	3935	5015	3035	3735	4135	5015
	Seat Depth	22¼"	Zone 4	2445	3045	3445	3945	5025	3045	3745	4145	5025
	Arm Height	25"										
	Width/B Arms	43"										
	COM	9½ yds.										
	COL	129 sq. ft.										
	Weight	118 lbs.										

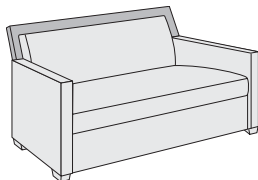

Upholstered with Wood Trim on Back

Two-Tone COM/COL*

- COM (Inside Back & Seat Cushion) 3¾ yds.
- COM (Outside Back, Arms, Front Panel) 5¾ yds.
- COL (Inside Back & Seat Cushion) 51 sq. ft.
- COL (Outside Back, Arms, Front Panel) 78 sq. ft.

Product Notes:

Optional wood arm cap - **add \$60 list**, please specify (-C).
 Optional square tufting on outside arms - **add \$50 list**, please specify (-TOA).
 Optional square tufting on inside back & seat - **add \$150 list**, please specify (-TBS).
 Available in all Taylor finishes.

***Two-tone upholstery applications will be priced at the higher of the two price grades.** If two fabrics from the same price grade are used, item will be priced at the next higher price grade. If two COMs are used, item will be priced at the COL price grade.

Model	Dimensions	Zone	COM	A	B	C	D	COL	L1	L2	L3	
2554T Hampton	Width	52½"	Will Call	2170	2770	3170	3670	4750	2770	3470	3870	4750
	Depth	33"	Zone 1	2445	3045	3445	3945	5025	3045	3745	4145	5025
	Height	32½"	Zone 2	2475	3075	3475	3975	5055	3075	3775	4175	5055
	Seat Height	19¼"	Zone 3	2485	3085	3485	3985	5065	3085	3785	4185	5065
	Seat Depth	21½"	Zone 4	2495	3095	3495	3995	5075	3095	3795	4195	5075
	Arm Height	25¾"										
	Width/B Arms	43"										
	COM	9½ yds.										
	COL	129 sq. ft.										
	Weight	118 lbs.										

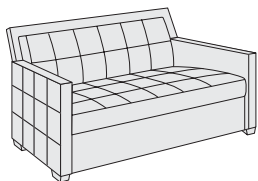

Upholstered with Square Tufting

Two-Tone COM/COL*

- COM (Inside Back & Seat Cushion) 3¾ yds.
- COM (Outside Back, Arms, Front Panel) 5¾ yds.
- COL (Inside Back & Seat Cushion) 51 sq. ft.
- COL (Outside Back, Arms, Front Panel) 78 sq. ft.

Product Notes:

Optional wood arm cap - **add \$60 list**, please specify (-C).
 Optional wood trim on back - **add \$120 list**, please specify (-W).
 Available in all Taylor finishes.

***Two-tone upholstery applications will be priced at the higher of the two price grades.** If two fabrics from the same price grade are used, item will be priced at the next higher price grade. If two COMs are used, item will be priced at the COL price grade.

Model	Dimensions	Zone	COM	A	B	C	D	COL	L1	L2	L3	
2555 Hampton	Width	52"	Will Call	2170	2770	3170	3670	4750	2770	3470	3870	4750
	Depth	33"	Zone 1	2445	3045	3445	3945	5025	3045	3745	4145	5025
	Height	32½"	Zone 2	2475	3075	3475	3975	5055	3075	3775	4175	5055
	Seat Height	19"	Zone 3	2485	3085	3485	3985	5065	3085	3785	4185	5065
	Seat Depth	22¼"	Zone 4	2495	3095	3495	3995	5075	3095	3795	4195	5075
	Arm Height	25"										
	Width/B Arms	43¾"										
	COM	8½ yds.										
	COL	112 sq. ft.										
	Weight	114 lbs.										

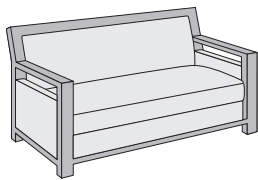

Beveled Wood Arm and Wood Trim on Back

Two-Tone COM/COL*

- COM (Inside Back & Seat Cushion) 3½ yds.
- COM (Outside Back, Arms, Front Panel) 4¾ yds.
- COL (Inside Back & Seat Cushion) 47 sq. ft.
- COL (Outside Back, Arms, Front Panel) 65 sq. ft.

Product Notes:

Optional square tufting on inside back & seat - **add \$150 list**, please specify (-TBS).
 Available in all Taylor finishes.

***Two-tone upholstery applications will be priced at the higher of the two price grades.** If two fabrics from the same price grade are used, item will be priced at the next higher price grade. If two COMs are used, item will be priced at the COL price grade.

LOUNGE & MULTIPLE

To specify, include:

- Model Number
- Wood Finish
- Fabric | Leather
- Quantity

Wood Finishes

- RCL Royal Cherry
- LWL Light Walnut
- ESP Espresso
- MHL Mahogany
- SMK Smoke
- CML Clear Maple
- COL Clear Oak
- CHY Cherry
- AMB Amber
- BLK Black

Graded-In Fabric | Leather

Specific grades for fabrics and leathers can be found on the separate grade cards found in your Taylor binder. For fabric and leather patterns not graded-in, please contact Customer Service for pricing.

Dimensions

Dimensions listed in this price book are in inches and approximate.

Freight

Zone list pricing includes freight prepaid by Taylor for delivery to one destination only within the zone. See pg. 5 for details.

Large Order Freight Discount

For orders with 20 units or more, please contact Customer Service for pricing.

Minimum Prepaid Freight Charges

Orders with **5 or less chairs** (in any combination of guest, swivel, lounge, etc.) will be charged **\$195 list per order**.

5 | 15

Five Rooms in Fifteen Days

Seating marked with this logo is a part of Taylor's "Five Rooms in Fifteen Days" program. Refer to page 11 for details.

Model	Dimensions	Zone	COM	A	B	C	D	COL	L1	L2	L3	
2556 Hampton	Width	44"	Will Call	1570	1945	2195	2495	3100	1945	2375	2620	3100
	Depth	31"	Zone 1	1845	2220	2470	2770	3375	2220	2650	2895	3375
	Height	32"	Zone 2	1875	2250	2500	2800	3405	2250	2680	2925	3405
	Seat Height	19"	Zone 3	1885	2260	2510	2810	3415	2260	2690	2935	3415
	Seat Depth	22¼"	Zone 4	1895	2270	2520	2820	3425	2270	2700	2945	3425
	COM	7 yds.										
	COL	94 sq. ft.										
	Weight	105 lbs.										

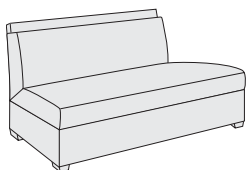

Armless,
Fully Upholstered

Product Notes:

Optional square tufting on inside back & seat - **add \$150 list**, please specify (-TBS). Available in all Taylor finishes.

Model	Dimensions	Zone	COM	A	B	C	D	COL	L1	L2	L3	
2556W Hampton	Width	44"	Will Call	1670	2045	2295	2595	3200	2045	2475	2720	3200
	Depth	31"	Zone 1	1945	2320	2570	2870	3475	2320	2750	2995	3475
	Height	32"	Zone 2	1975	2350	2600	2900	3505	2350	2780	3025	3505
	Seat Height	19"	Zone 3	1985	2360	2610	2910	3515	2360	2790	3035	3515
	Seat Depth	22¼"	Zone 4	1995	2370	2620	2920	3525	2370	2800	3045	3525
	COM	7 yds.										
	COL	94 sq. ft.										
	Weight	105 lbs.										

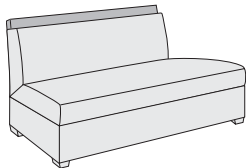

Armless, Upholstered
with Wood Trim on Back

Product Notes:

Optional square tufting on inside back & seat - **add \$150 list**, please specify (-TBS). Available in all Taylor finishes.

Model	Dimensions	Zone	COM	A	B	C	D	COL	L1	L2	L3	
2574 Hampton	Width	74"	Will Call	2485	3280	3810	4335	5725	3280	4085	4635	5725
	Depth	33"	Zone 1	2825	3620	4150	4675	6065	3620	4425	4975	6065
	Height	32½"	Zone 2	2860	3655	4185	4710	6100	3655	4460	5010	6100
	Seat Height	19"	Zone 3	2870	3665	4195	4720	6110	3665	4470	5020	6110
	Seat Depth	22¼"	Zone 4	2880	3675	4205	4730	6120	3675	4480	5030	6120
	Arm Height	25"										
	Width/B Arms	65"										
	COM	12 yds.										
COL	167 sq. ft.											
Weight	143 lbs.											

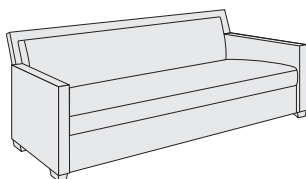

Fully Upholstered

Two-Tone COM/COL*

- COM (Inside Back & Seat Cushion) 5½ yds.
- COM (Outside Back, Arms, Front Panel) 6½ yds.
- COL (Inside Back & Seat Cushion) 74 sq. ft.
- COL (Outside Back, Arms, Front Panel) 88 sq. ft.

Product Notes:

Optional square tufting on outside arms - **add \$50 list**, please specify (-TOA).
Optional square tufting on inside back & seat - **add \$225 list**, please specify (-TBS). Available in all Taylor finishes.

***Two-tone upholstery applications will be priced at the higher of the two price grades.** If two fabrics from the same price grade are used, item will be priced at the next higher price grade. If two COMs are used, item will be priced at the COL price grade.

To specify, include:

- Model Number
- Wood Finish
- Fabric | Leather
- Quantity

Wood Finishes

- **RCL** Royal Cherry
- **LWL** Light Walnut
- **ESP** Espresso
- **MHL** Mahogany
- **SMK** Smoke
- **CML** Clear Maple
- **COL** Clear Oak
- **CHY** Cherry
- **AMB** Amber
- **BLK** Black

Graded-In Fabric | Leather

Specific grades for fabrics and leathers can be found on the separate grade cards found in your Taylor binder. For fabric and leather patterns not graded-in, please contact Customer Service for pricing.

Dimensions

Dimensions listed in this price book are in inches and approximate.

Freight

Zone list pricing includes freight prepaid by Taylor for delivery to one destination only within the zone. See pg. 5 for details.

Large Order Freight Discount

For orders with 20 units or more, please contact Customer Service for pricing.

Minimum Prepaid Freight Charges

Orders with **5 or less chairs** (in any combination of guest, swivel, lounge, etc.) will be charged **\$195 list per order**.

5 | 15

Five Rooms in Fifteen Days

Seating marked with this logo is a part of Taylor's "Five Rooms in Fifteen Days" program. Refer to page 11 for details.

Model	Dimensions	Zone	COM	A	B	C	D	COL	L1	L2	L3	
2574C Hampton	Width	74"	Will Call	2535	3330	3860	4385	5775	3330	4135	4685	5775
	Depth	33"	Zone 1	2875	3670	4200	4725	6115	3670	4475	5025	6115
	Height	32½"	Zone 2	2910	3705	4235	4760	6150	3705	4510	5060	6150
	Seat Height	19"	Zone 3	2920	3715	4245	4770	6160	3715	4520	5070	6160
	Seat Depth	22¼"	Zone 4	2930	3725	4255	4780	6170	3725	4530	5080	6170
	Arm Height	25"										
	Width/B Arms	65"										
	COM	12 yds.										
	COL	167 sq. ft.										
	Weight	143 lbs.										

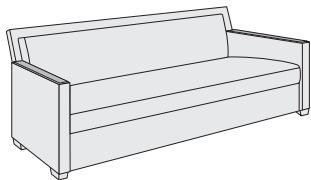

Upholstered with Wood Arm Cap

Two-Tone COM/COL*
 COM (Inside Back & Seat Cushion) 5½ yds.
 COM (Outside Back, Arms, Front Panel) 6½ yds.
 COL (Inside Back & Seat Cushion) 74 sq. ft.
 COL (Outside Back, Arms, Front Panel) 88 sq. ft.

Product Notes:

Optional square tufting on outside arms - **add \$50 list**, please specify (-TOA).
 Optional square tufting on inside back & seat - **add \$225 list**, please specify (-TBS).
 Available in all Taylor finishes.

***Two-tone upholstery applications will be priced at the higher of the two price grades.** If two fabrics from the same price grade are used, item will be priced at the next higher price grade. If two COMs are used, item will be priced at the COL price grade.

Model	Dimensions	Zone	COM	A	B	C	D	COL	L1	L2	L3	
2574W Hampton	Width	74"	Will Call	2635	3430	3960	4485	5875	3430	4235	4785	5875
	Depth	33"	Zone 1	2975	3770	4300	4825	6215	3770	4575	5125	6215
	Height	32½"	Zone 2	3010	3805	4335	4860	6250	3805	4610	5160	6250
	Seat Height	19"	Zone 3	3020	3815	4345	4870	6260	3815	4620	5170	6260
	Seat Depth	22¼"	Zone 4	3030	3825	4355	4880	6270	3825	4630	5180	6270
	Arm Height	25"										
	Width/B Arms	65"										
	COM	12 yds.										
	COL	167 sq. ft.										
	Weight	143 lbs.										

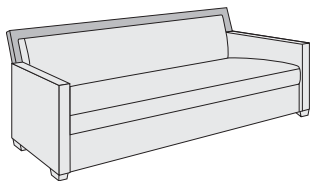

Upholstered with Wood Trim on Back

Two-Tone COM/COL*
 COM (Inside Back & Seat Cushion) 5½ yds.
 COM (Outside Back, Arms, Front Panel) 6½ yds.
 COL (Inside Back & Seat Cushion) 74 sq. ft.
 COL (Outside Back, Arms, Front Panel) 88 sq. ft.

Product Notes:

Optional wood arm cap - **add \$60 list**, please specify (-C).
 Optional square tufting on outside arms - **add \$50 list**, please specify (-TOA).
 Optional square tufting on inside back & seat - **add \$225 list**, please specify (-TBS).
 Available in all Taylor finishes.

***Two-tone upholstery applications will be priced at the higher of the two price grades.** If two fabrics from the same price grade are used, item will be priced at the next higher price grade. If two COMs are used, item will be priced at the COL price grade.

Model	Dimensions	Zone	COM	A	B	C	D	COL	L1	L2	L3	
2574T Hampton	Width	74½"	Will Call	2685	3480	4010	4535	5925	3480	4285	4835	5925
	Depth	33"	Zone 1	3025	3820	4350	4875	6265	3820	4625	5175	6265
	Height	32½"	Zone 2	3060	3855	4385	4910	6300	3855	4660	5210	6300
	Seat Height	19¼"	Zone 3	3070	3865	4395	4920	6310	3865	4670	5220	6310
	Seat Depth	21½"	Zone 4	3080	3875	4405	4930	6320	3875	4680	5230	6320
	Arm Height	25¾"										
	Width/B Arms	65"										
	COM	12½ yds.										
	COL	169 sq. ft.										
	Weight	143 lbs.										

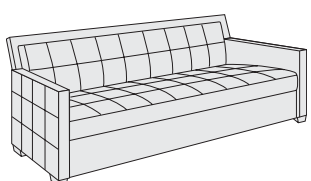

Upholstered with Square Tufting

Two-Tone COM/COL*
 COM (Inside Back & Seat Cushion) 5¾ yds.
 COM (Outside Back, Arms, Front Panel) 6¾ yds.
 COL (Inside Back & Seat Cushion) 78 sq. ft.
 COL (Outside Back, Arms, Front Panel) 91 sq. ft.

Product Notes:

Optional wood arm cap - **add \$60 list**, please specify (-C).
 Optional wood trim on back - **add \$180 list**, please specify (-W).
 Available in all Taylor finishes.

***Two-tone upholstery applications will be priced at the higher of the two price grades.** If two fabrics from the same price grade are used, item will be priced at the next higher price grade. If two COMs are used, item will be priced at the COL price grade.

LOUNGE & MULTIPLE

To specify, include:

- Model Number
- Wood Finish
- Fabric | Leather
- Quantity

Wood Finishes

- RCL Royal Cherry
- LWL Light Walnut
- ESP Espresso
- MHL Mahogany
- SMK Smoke
- CML Clear Maple
- COL Clear Oak
- CHY Cherry
- AMB Amber
- BLK Black

Graded-In Fabric | Leather

Specific grades for fabrics and leathers can be found on the separate grade cards found in your Taylor binder. For fabric and leather patterns not graded-in, please contact Customer Service for pricing.

Dimensions

Dimensions listed in this price book are in inches and approximate.

Freight

Zone list pricing includes freight prepaid by Taylor for delivery to one destination only within the zone. See pg. 5 for details.

Large Order Freight Discount

For orders with 20 units or more, please contact Customer Service for pricing.

Minimum Prepaid Freight Charges

Orders with **5 or less chairs** (in any combination of guest, swivel, lounge, etc.) will be charged **\$195 list per order**.

5 | 15

Five Rooms in Fifteen Days

Seating marked with this logo is a part of Taylor's "Five Rooms in Fifteen Days" program. Refer to page 11 for details.

Model	Dimensions	Zone	COM	A	B	C	D	COL	L1	L2	L3	
2575 Hampton	Width	74"	Will Call	2685	3480	4010	4535	5925	3480	4285	4835	5925
	Depth	33"	Zone 1	3025	3820	4350	4875	6265	3820	4625	5175	6265
	Height	32½"	Zone 2	3060	3855	4385	4910	6300	3855	4660	5210	6300
	Seat Height	19"	Zone 3	3070	3865	4395	4920	6310	3865	4670	5220	6310
	Seat Depth	22¼"	Zone 4	3080	3875	4405	4930	6320	3875	4680	5230	6320
	Arm Height	25"										
	Width/B Arms	65¾"										
	COM	11½ yds.										

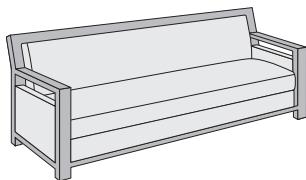

Beveled Wood Arm and Wood Trim on Back

Two-Tone COM/COL*

- COM (Inside Back & Seat Cushion) 5½ yds.
- COM (Outside Back, Arms, Front Panel) 6 yds.
- COL (Inside Back & Seat Cushion) 74 sq. ft.
- COL (Outside Back, Arms, Front Panel) 81 sq. ft.

Product Notes:

Optional square tufting on inside back & seat - **add \$225 list**, please specify (-TBS). Available in all Taylor finishes.

***Two-tone upholstery applications will be priced at the higher of the two price grades.** If two fabrics from the same price grade are used, item will be priced at the next higher price grade. If two COMs are used, item will be priced at the COL price grade.

Model	Dimensions	Zone	COM	A	B	C	D	COL	L1	L2	L3	
2576 Hampton	Width	66"	Will Call	2085	2655	3035	3360	4275	2655	3190	3585	4275
	Depth	31"	Zone 1	2425	2995	3375	3700	4615	2995	3530	3925	4615
	Height	32"	Zone 2	2460	3030	3410	3735	4650	3030	3565	3960	4650
	Seat Height	19"	Zone 3	2470	3040	3420	3745	4660	3040	3575	3970	4660
	Seat Depth	22¼"	Zone 4	2480	3050	3430	3755	4670	3050	3585	3980	4670
	COM	9½ yds.										
	COL	128 sq. ft.										
	Weight	126 lbs.										

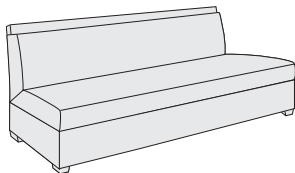

Armless, Fully Upholstered

Product Notes:

Optional square tufting on inside back & seat - **add \$225 list**, please specify (-TBS). Available in all Taylor finishes.

Model	Dimensions	Zone	COM	A	B	C	D	COL	L1	L2	L3	
2576W Hampton	Width	66"	Will Call	2235	2805	3185	3510	4425	2805	3340	3785	4425
	Depth	31"	Zone 1	2575	3145	3525	3850	4765	3145	3680	4125	4765
	Height	32"	Zone 2	2610	3180	3560	3885	4800	3180	3715	4160	4800
	Seat Height	19"	Zone 3	2620	3190	3570	3895	4810	3190	3725	4170	4810
	Seat Depth	22¼"	Zone 4	2630	3200	3580	3905	4820	3200	3735	4180	4820
	COM	9½ yds.										
	COL	128 sq. ft.										
	Weight	126 lbs.										

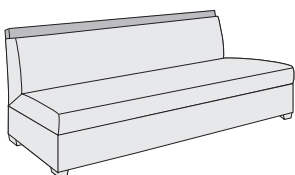

Armless, Upholstered with Wood Trim on Back

Product Notes:

Optional square tufting on inside back & seat - **add \$225 list**, please specify (-TBS). Available in all Taylor finishes.

LOUNGE & MULTIPLE

To specify, include:

- Model Number
- Wood Finish
- Fabric | Leather
- Quantity

Wood Finishes

- RCL Royal Cherry
- LWL Light Walnut
- ESP Espresso
- MHL Mahogany
- SMK Smoke
- CML Clear Maple
- COL Clear Oak
- CHY Cherry
- AMB Amber
- BLK Black

Graded-In Fabric | Leather

Specific grades for fabrics and leathers can be found on the separate grade cards found in your Taylor binder. For fabric and leather patterns not graded-in, please contact Customer Service for pricing.

Dimensions

Dimensions listed in this price book are in inches and approximate.

Freight

Zone list pricing includes freight prepaid by Taylor for delivery to one destination only within the zone. See pg. 5 for details.

Large Order Freight Discount

For orders with 20 units or more, please contact Customer Service for pricing.

Minimum Prepaid Freight Charges

Orders with 5 or less chairs (in any combination of guest, swivel, lounge, etc.) will be charged \$195 list per order.

5 | 15

Five Rooms in Fifteen Days

Seating marked with this logo is a part of Taylor's "Five Rooms in Fifteen Days" program. Refer to page 11 for details.

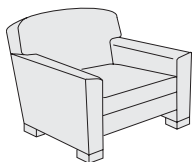
Model	Dimensions	Zone	COM	A	B	C	D	COL	L1	L2	L3	
9336 Elwood	 Width 35" Depth 32" Height 32" Seat Height 19" Seat Depth 19 3/4" Arm Height 23 1/4" Width/B Arms 23 1/4" COM 7 3/4 yds. COL 105 sq. ft. Weight 79 lbs.	Will Call	1370	1865	2200	2530	3415	1865	2365	2700	3415	
		Zone 1	1560	2055	2390	2720	3605	2055	2555	2890	3605	
		Zone 2	1595	2090	2425	2755	3640	2090	2590	2925	3640	
		Zone 3	1600	2095	2430	2760	3645	2095	2595	2930	3645	
		Zone 4	1610	2105	2440	2770	3655	2105	2605	2940	3655	
		Product Notes: Optional contrasting welts - add \$95 list, please specify. Available in all Taylor finishes.										
		*Two-tone upholstery applications will be priced at the higher of the two price grades. If two fabrics from the same price grade are used, item will be priced at the next higher price grade. If two COMs are used, item will be priced at the COL price grade.										
		Two-Tone COM/COL* COM (Outside Back & Arms, Front Panel) 2 1/2 yds. COM (Inside Back & Arms, Seat) 5 3/4 yds. COL (Outside Back & Arms, Front Panel) 34 sq. ft. COL (Inside Back & Arms, Seat) 78 sq. ft.										
		 Wood Leg										

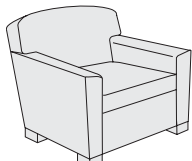
Model	Dimensions	Zone	COM	A	B	C	D	COL	L1	L2	L3	
9336FP Elwood	 Width 35" Depth 32" Height 32" Seat Height 19" Seat Depth 19 3/4" Arm Height 23 1/4" Width/B Arms 23 1/4" COM 8 1/4 yds. COL 112 sq. ft. Weight 79 lbs.	Will Call	1405	1895	2230	2565	3465	1895	2395	2730	3465	
		Zone 1	1595	2085	2420	2755	3655	2085	2585	2920	3655	
		Zone 2	1630	2120	2455	2790	3690	2120	2620	2955	3690	
		Zone 3	1635	2125	2460	2795	3695	2125	2625	2960	3695	
		Zone 4	1645	2135	2470	2805	3705	2135	2635	2970	3705	
		Product Notes: Optional contrasting welts - add \$95 list, please specify. Available in all Taylor finishes.										
		*Two-tone upholstery applications will be priced at the higher of the two price grades. If two fabrics from the same price grade are used, item will be priced at the next higher price grade. If two COMs are used, item will be priced at the COL price grade.										
		Two-Tone COM/COL* COM (Outside Back & Arms, Front Panel) 2 3/4 yds. COM (Inside Back & Arms, Seat) 5 3/4 yds. COL (Outside Back & Arms, Front Panel) 37 sq. ft. COL (Inside Back & Arms, Seat) 78 sq. ft.										
		 Front Panel, Wood Leg										

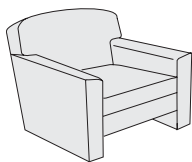
Model	Dimensions	Zone	COM	A	B	C	D	COL	L1	L2	L3	
9337 Elwood	 Width 35" Depth 32" Height 32" Seat Height 19" Seat Depth 19 3/4" Arm Height 23 1/4" Width/B Arms 23 1/4" COM 7 3/4 yds. COL 105 sq. ft. Weight 79 lbs.	Will Call	1405	1905	2240	2575	3475	1905	2405	2740	3475	
		Zone 1	1595	2095	2430	2765	3665	2095	2595	2930	3665	
		Zone 2	1630	2130	2465	2800	3700	2130	2630	2965	3700	
		Zone 3	1635	2135	2470	2805	3705	2135	2635	2970	3705	
		Zone 4	1645	2145	2480	2815	3715	2145	2645	2980	3715	
		Product Notes: Optional contrasting welts - add \$95 list, please specify.										
		*Two-tone upholstery applications will be priced at the higher of the two price grades. If two fabrics from the same price grade are used, item will be priced at the next higher price grade. If two COMs are used, item will be priced at the COL price grade.										
		Two-Tone COM/COL* COM (Outside Back & Arms, Front Panel) 2 1/2 yds. COM (Inside Back & Arms, Seat) 5 3/4 yds. COL (Outside Back & Arms, Front Panel) 34 sq. ft. COL (Inside Back & Arms, Seat) 78 sq. ft.										
												

LOUNGE & MULTIPLE

To specify, include:

- Model Number
- Wood Finish
- Fabric | Leather
- Quantity

Wood Finishes

- RCL Royal Cherry
- LWL Light Walnut
- ESP Espresso
- MHL Mahogany
- SMK Smoke
- CML Clear Maple
- COL Clear Oak
- CHY Cherry
- AMB Amber
- BLK Black

Graded-In Fabric | Leather

Specific grades for fabrics and leathers can be found on the separate grade cards found in your Taylor binder. For fabric and leather patterns not graded-in, please contact Customer Service for pricing.

Dimensions

Dimensions listed in this price book are in inches and approximate.

Freight

Zone list pricing includes freight prepaid by Taylor for delivery to one destination only within the zone. See pg. 5 for details.

Large Order Freight Discount

For orders with 20 units or more, please contact Customer Service for pricing.

Minimum Prepaid Freight Charges

Orders with 5 or less chairs (in any combination of guest, swivel, lounge, etc.) will be charged \$195 list per order.

5 | 15

Five Rooms in Fifteen Days

Seating marked with this logo is a part of Taylor's "Five Rooms in Fifteen Days" program. Refer to page 11 for details.

Model	Dimensions	Zone	COM	A	B	C	D	COL	L1	L2	L3	
9337FP Elwood	Width	35"	Will Call	1435	1965	2320	2670	3575	1965	2495	2850	3575
	Depth	32"	Zone 1	1625	2155	2510	2860	3765	2155	2685	3040	3765
	Height	32"	Zone 2	1660	2190	2545	2895	3800	2190	2720	3075	3800
	Seat Height	19"	Zone 3	1665	2195	2550	2900	3805	2195	2725	3080	3805
	Seat Depth	19¾"	Zone 4	1675	2205	2560	2910	3815	2205	2735	3090	3815
	Arm Height	23¼"										
	Width/B Arms	23¼"										
	COM	8¼ yds.										
	COL	112 sq. ft.										
	Weight	79 lbs.										

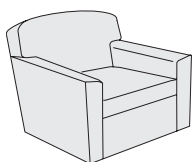

Front Panel

5 | 15

Two-Tone COM/COL*

- COM (Outside Back & Arms, Front Panel) 2¾ yds.
- COM (Inside Back & Arms, Seat) 5¼ yds.
- COL (Outside Back & Arms, Front Panel) 37 sq. ft.
- COL (Inside Back & Arms, Seat) 78 sq. ft.

Product Notes:

Optional contrasting welts - add \$95 list, please specify.

*Two-tone upholstery applications will be priced at the higher of the two price grades. If two fabrics from the same price grade are used, item will be priced at the next higher price grade. If two COMs are used, item will be priced at the COL price grade.

Model	Dimensions	Zone	COM	A	B	C	D	COL	L1	L2	L3	
9360 Elwood	Width	59"	Will Call	1925	2625	3095	3560	4785	2625	3325	3795	4785
	Depth	32"	Zone 1	2200	2900	3370	3835	5060	2900	3600	4070	5060
	Height	32"	Zone 2	2230	2930	3400	3865	5090	2930	3630	4100	5090
	Seat Height	19"	Zone 3	2240	2940	3410	3875	5100	2940	3640	4110	5100
	Seat Depth	19¾"	Zone 4	2250	2950	3420	3885	5110	2950	3650	4120	5110
	Arm Height	23¼"										
	Width/B Arms	47¼"										
	COM	10¾ yds.										
	COL	145 sq. ft.										
	Weight	109 lbs.										

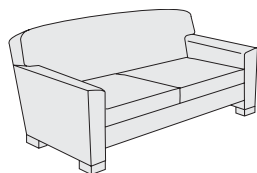

Wood Leg

Two-Tone COM/COL*

- COM (Outside Back & Arms, Front Panel) 2½ yds.
- COM (Inside Back & Arms, Seat) 8¼ yds.
- COL (Outside Back & Arms, Front Panel) 34 sq. ft.
- COL (Inside Back & Arms, Seat) 112 sq. ft.

Product Notes:

Optional contrasting welts - add \$125 list, please specify. Available in all Taylor finishes.

*Two-tone upholstery applications will be priced at the higher of the two price grades. If two fabrics from the same price grade are used, item will be priced at the next higher price grade. If two COMs are used, item will be priced at the COL price grade.

Model	Dimensions	Zone	COM	A	B	C	D	COL	L1	L2	L3	
9360FP Elwood	Width	59"	Will Call	1975	2675	3145	3615	4865	2675	3380	3845	4865
	Depth	32"	Zone 1	2250	2950	3420	3890	5140	2950	3655	4120	5140
	Height	32"	Zone 2	2280	2980	3450	3920	5170	2980	3685	4150	5170
	Seat Height	19"	Zone 3	2290	2990	3460	3930	5180	2990	3695	4160	5180
	Seat Depth	19¾"	Zone 4	2300	3000	3470	3940	5190	3000	3705	4170	5190
	Arm Height	23¼"										
	Width/B Arms	47¼"										
	COM	11¾ yds.										
	COL	160 sq. ft.										
	Weight	109 lbs.										

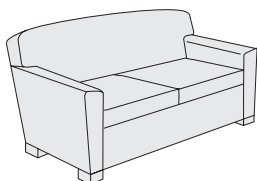

Front Panel,
Wood Leg

Two-Tone COM/COL*

- COM (Outside Back & Arms, Front Panel) 3½ yds.
- COM (Inside Back & Arms, Seat) 8¼ yds.
- COL (Outside Back & Arms, Front Panel) 48 sq. ft.
- COL (Inside Back & Arms, Seat) 112 sq. ft.

Product Notes:

Optional contrasting welts - add \$125 list, please specify. Available in all Taylor finishes.

*Two-tone upholstery applications will be priced at the higher of the two price grades. If two fabrics from the same price grade are used, item will be priced at the next higher price grade. If two COMs are used, item will be priced at the COL price grade.

LOUNGE & MULTIPLE

To specify, include:

- Model Number
- Wood Finish
- Fabric | Leather
- Quantity

Wood Finishes

- RCL Royal Cherry
- LWL Light Walnut
- ESP Espresso
- MHL Mahogany
- SMK Smoke
- CML Clear Maple
- COL Clear Oak
- CHY Cherry
- AMB Amber
- BLK Black

Graded-In Fabric | Leather

Specific grades for fabrics and leathers can be found on the separate grade cards found in your Taylor binder. For fabric and leather patterns not graded-in, please contact Customer Service for pricing.

Dimensions

Dimensions listed in this price book are in inches and approximate.

Freight

Zone list pricing includes freight prepaid by Taylor for delivery to one destination only within the zone. See pg. 5 for details.

Large Order Freight Discount

For orders with 20 units or more, please contact Customer Service for pricing.

Minimum Prepaid Freight Charges

Orders with 5 or less chairs (in any combination of guest, swivel, lounge, etc.) will be charged \$195 list per order.

5 | 15

Five Rooms in Fifteen Days

Seating marked with this logo is a part of Taylor's "Five Rooms in Fifteen Days" program. Refer to page 11 for details.

Model	Dimensions	Zone	COM	A	B	C	D	COL	L1	L2	L3	
9361 Elwood	Width	59"	Will Call	1950	2650	3120	3585	4820	2650	3355	3820	4820
	Depth	32"	Zone 1	2225	2925	3395	3860	5095	2925	3630	4095	5095
	Height	32"	Zone 2	2255	2955	3425	3890	5125	2955	3660	4125	5125
	Seat Height	19"	Zone 3	2265	2965	3435	3900	5135	2965	3670	4135	5135
	Seat Depth	19¾"	Zone 4	2275	2975	3445	3910	5145	2975	3680	4145	5145
	Arm Height	23¼"										
	Width/B Arms	47¼"										
	COM	10¾ yds.										
	COL	145 sq. ft.										
Weight	109 lbs.											

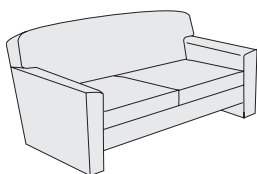

Two-Tone COM/COL*

- COM (Outside Back & Arms, Front Panel) 2½ yds.
- COM (Inside Back & Arms, Seat) 8¼ yds.
- COL (Outside Back & Arms, Front Panel) 34 sq. ft.
- COL (Inside Back & Arms, Seat) 112 sq. ft.

Product Notes:

Optional contrasting welts - add \$125 list, please specify.

*Two-tone upholstery applications will be priced at the higher of the two price grades. If two fabrics from the same price grade are used, item will be priced at the next higher price grade. If two COMs are used, item will be priced at the COL price grade.

Model	Dimensions	Zone	COM	A	B	C	D	COL	L1	L2	L3	
9361FP Elwood	Width	59"	Will Call	2000	2705	3170	3640	4925	2705	3405	3875	4925
	Depth	32"	Zone 1	2275	2980	3445	3915	5200	2980	3680	4150	5200
	Height	32"	Zone 2	2305	3010	3475	3945	5230	3010	3710	4180	5230
	Seat Height	19"	Zone 3	2315	3020	3485	3955	5240	3020	3720	4190	5240
	Seat Depth	19¾"	Zone 4	2325	3030	3495	3965	5250	3030	3730	4200	5250
	Arm Height	23¼"										
	Width/B Arms	47¼"										
	COM	11¾ yds.										
	COL	160 sq. ft.										
Weight	109 lbs.											

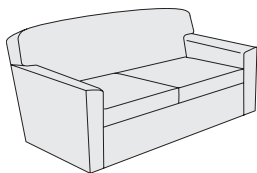

Front Panel

Two-Tone COM/COL*

- COM (Outside Back & Arms, Front Panel) 3½ yds.
- COM (Inside Back & Arms, Seat) 8¼ yds.
- COL (Outside Back & Arms, Front Panel) 48 sq. ft.
- COL (Inside Back & Arms, Seat) 112 sq. ft.

Product Notes:

Optional contrasting welts - add \$125 list, please specify.

*Two-tone upholstery applications will be priced at the higher of the two price grades. If two fabrics from the same price grade are used, item will be priced at the next higher price grade. If two COMs are used, item will be priced at the COL price grade.

Model	Dimensions	Zone	COM	A	B	C	D	COL	L1	L2	L3	
9384 Elwood	Width	83"	Will Call	2385	3290	3895	4495	6095	3290	4195	4800	6095
	Depth	32"	Zone 1	2725	3630	4235	4835	6435	3630	4535	5140	6435
	Height	32"	Zone 2	2760	3665	4270	4870	6470	3665	4570	5175	6470
	Seat Height	19"	Zone 3	2770	3675	4280	4880	6480	3675	4580	5185	6480
	Seat Depth	19¾"	Zone 4	2780	3685	4290	4890	6490	3685	4590	5195	6490
	Arm Height	23¼"										
	Width/B Arms	71¼"										
	COM	13¼ yds.										
	COL	180 sq. ft.										
Weight	129 lbs.											

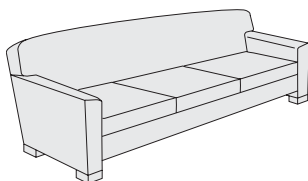

Wood Leg

Two-Tone COM/COL*

- COM (Outside Back & Arms, Front Panel) 3 yds.
- COM (Inside Back & Arms, Seat) 10½ yds.
- COL (Outside Back & Arms, Front Panel) 41 sq. ft.
- COL (Inside Back & Arms, Seat) 142 sq. ft.

Product Notes:

Optional contrasting welts - add \$150 list, please specify. Available in all Taylor finishes.

*Two-tone upholstery applications will be priced at the higher of the two price grades. If two fabrics from the same price grade are used, item will be priced at the next higher price grade. If two COMs are used, item will be priced at the COL price grade.

LOUNGE & MULTIPLE

To specify, include:

- Model Number
- Wood Finish
- Fabric | Leather
- Quantity

Wood Finishes

- RCL Royal Cherry
- LWL Light Walnut
- ESP Espresso
- MHL Mahogany
- SMK Smoke
- CML Clear Maple
- COL Clear Oak
- CHY Cherry
- AMB Amber
- BLK Black

Graded-In Fabric | Leather

Specific grades for fabrics and leathers can be found on the separate grade cards found in your Taylor binder. For fabric and leather patterns not graded-in, please contact Customer Service for pricing.

Dimensions

Dimensions listed in this price book are in inches and approximate.

Freight

Zone list pricing includes freight prepaid by Taylor for delivery to one destination only within the zone. See pg. 5 for details.

Large Order Freight Discount

For orders with 20 units or more, please contact Customer Service for pricing.

Minimum Prepaid Freight Charges

Orders with 5 or less chairs (in any combination of guest, swivel, lounge, etc.) will be charged \$195 list per order.

5 | 15

Five Rooms in Fifteen Days

Seating marked with this logo is a part of Taylor's "Five Rooms in Fifteen Days" program. Refer to page 11 for details.

Model	Dimensions	Zone	COM	A	B	C	D	COL	L1	L2	L3	
9384FP Elwood	Width	83"	Will Call	2460	3370	3970	4575	6215	3370	4275	4875	6215
	Depth	32"	Zone 1	2800	3710	4310	4915	6555	3710	4615	5215	6555
	Height	32"	Zone 2	2835	3745	4345	4950	6590	3745	4650	5250	6590
	Seat Height	19"	Zone 3	2845	3755	4355	4960	6600	3755	4660	5260	6600
	Seat Depth	19¾"	Zone 4	2855	3765	4365	4970	6610	3765	4670	5270	6610
	Arm Height	23¼"										
	Width/B Arms	71¼"										
	COM	14¾ yds.										
	COL	200 sq. ft.										
	Weight	129 lbs.										

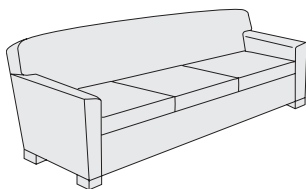

Front Panel,
Wood Leg

Two-Tone COM/COL*

- COM (Outside Back & Arms, Front Panel) 4½ yds.
- COM (Inside Back & Arms, Seat) 10½ yds.
- COL (Outside Back & Arms, Front Panel) 61 sq. ft.
- COL (Inside Back & Arms, Seat) 142 sq. ft.

Product Notes:

Optional contrasting welts - **add \$150 list**, please specify. Available in all Taylor finishes.

***Two-tone upholstery applications will be priced at the higher of the two price grades.** If two fabrics from the same price grade are used, item will be priced at the next higher price grade. If two COMs are used, item will be priced at the COL price grade.

Model	Dimensions	Zone	COM	A	B	C	D	COL	L1	L2	L3	
9385 Elwood	Width	83"	Will Call	2410	3315	3920	4525	6130	3315	4220	4825	6130
	Depth	32"	Zone 1	2750	3655	4260	4865	6470	3655	4560	5165	6470
	Height	32"	Zone 2	2785	3690	4295	4900	6505	3690	4595	5200	6505
	Seat Height	19"	Zone 3	2795	3700	4305	4910	6515	3700	4605	5210	6515
	Seat Depth	19¾"	Zone 4	2805	3710	4315	4920	6525	3710	4615	5220	6525
	Arm Height	23¼"										
	Width/B Arms	71¼"										
	COM	13¼ yds.										
	COL	180 sq. ft.										
	Weight	129 lbs.										

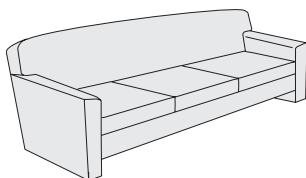

Two-Tone COM/COL*

- COM (Outside Back & Arms, Front Panel) 3 yds.
- COM (Inside Back & Arms, Seat) 10½ yds.
- COL (Outside Back & Arms, Front Panel) 41 sq. ft.
- COL (Inside Back & Arms, Seat) 142 sq. ft.

Product Notes:

Optional contrasting welts - **add \$150 list**, please specify.

***Two-tone upholstery applications will be priced at the higher of the two price grades.** If two fabrics from the same price grade are used, item will be priced at the next higher price grade. If two COMs are used, item will be priced at the COL price grade.

Model	Dimensions	Zone	COM	A	B	C	D	COL	L1	L2	L3	
9385FP Elwood	Width	83"	Will Call	2485	3395	3995	4600	6250	3395	4300	4900	6250
	Depth	32"	Zone 1	2825	3735	4335	4940	6590	3735	4640	5240	6590
	Height	32"	Zone 2	2860	3770	4370	4975	6625	3770	4675	5275	6625
	Seat Height	19"	Zone 3	2870	3780	4380	4985	6635	3780	4685	5285	6635
	Seat Depth	19¾"	Zone 4	2880	3790	4390	4995	6645	3790	4695	5295	6645
	Arm Height	23¼"										
	Width/B Arms	71¼"										
	COM	14¾ yds.										
	COL	200 sq. ft.										
	Weight	129 lbs.										

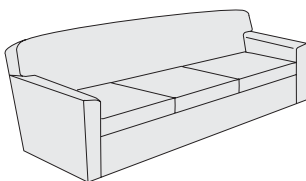

Front Panel

Two-Tone COM/COL*

- COM (Outside Back & Arms, Front Panel) 4½ yds.
- COM (Inside Back & Arms, Seat) 10½ yds.
- COL (Outside Back & Arms, Front Panel) 61 sq. ft.
- COL (Inside Back & Arms, Seat) 142 sq. ft.

Product Notes:

Optional contrasting welts - **add \$150 list**, please specify.

***Two-tone upholstery applications will be priced at the higher of the two price grades.** If two fabrics from the same price grade are used, item will be priced at the next higher price grade. If two COMs are used, item will be priced at the COL price grade.

To specify, include:

- Model Number
- Wood Finish
- Fabric | Leather
- Quantity

Wood Finishes

- RCL Royal Cherry
- LWL Light Walnut
- ESP Espresso
- MHL Mahogany
- SMK Smoke
- CML Clear Maple
- COL Clear Oak
- CHY Cherry
- AMB Amber
- BLK Black

Graded-In Fabric | Leather

Specific grades for fabrics and leathers can be found on the separate grade cards found in your Taylor binder. For fabric and leather patterns not graded-in, please contact Customer Service for pricing.

Dimensions

Dimensions listed in this price book are in inches and approximate.

Freight

Zone list pricing includes freight prepaid by Taylor for delivery to one destination only within the zone. See pg. 5 for details.

Large Order Freight Discount

For orders with 20 units or more, please contact Customer Service for pricing.

Minimum Prepaid Freight Charges

Orders with **5 or less chairs** (in any combination of guest, swivel, lounge, etc.) will be charged **\$195 list per order**.

5 | 15

Five Rooms in Fifteen Days

Seating marked with this logo is a part of Taylor's "Five Rooms in Fifteen Days" program. Refer to page 11 for details.

Model	Dimensions	Zone	COM	A	B	C	D	COL	L1	L2	L3	
9920COS Cosmo	Width	22"	Will Call	590	750	850	955	1170	750	905	1010	1170
	Depth	22"	Zone 1	675	835	935	1040	1255	835	990	1095	1255
	Height	19"	Zone 2	685	845	945	1050	1265	845	1000	1105	1265
	COM	2 yds.	Zone 3	690	850	950	1055	1270	850	1005	1110	1270
	COL	27 sq. ft.	Zone 4	700	860	960	1065	1280	860	1015	1120	1280
	Weight	27 lbs.										

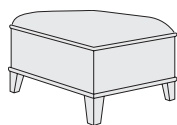

Ottoman

Product Notes:

Optional contrasting welts - **add \$95 list**, please specify.
Available in all Taylor finishes.

Model	Dimensions	Zone	COM	A	B	C	D	COL	L1	L2	L3	
9920MAX Maxwell 9920SAV Savannah 9920SLB Shelby	Width	22"	Will Call	590	750	850	955	1170	750	905	1010	1170
	Depth	22"	Zone 1	675	835	935	1040	1255	835	990	1095	1255
	Height	19"	Zone 2	685	845	945	1050	1265	845	1000	1105	1265
	COM	2 yds.	Zone 3	690	850	950	1055	1270	850	1005	1110	1270
	COL	27 sq. ft.	Zone 4	700	860	960	1065	1280	860	1015	1120	1280
	Weight	27 lbs.										

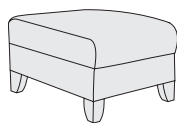

Ottoman



Product Notes:

Optional metal leg with satin nickel finish - **add \$50 list**, please specify (-ML).

Standard wood leg available in all Taylor finishes.

Model	Dimensions	Zone	COM	A	B	C	D	COL	L1	L2	L3	
9920MET Metro	Width	22"	Will Call	640	765	855	960	1215	765	910	1015	1215
	Depth	22"	Zone 1	725	850	940	1045	1300	850	995	1100	1300
	Height	19"	Zone 2	735	860	950	1055	1310	860	1005	1110	1310
	COM	2 yds.	Zone 3	740	865	955	1060	1315	865	1010	1115	1315
	COL	27 sq. ft.	Zone 4	750	875	965	1070	1325	875	1020	1125	1325
	Weight	27 lbs.										

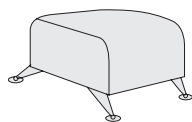

Ottoman

LOUNGE & MULTIPLE

To specify, include:

- Model Number
- Wood Finish
- Fabric | Leather
- Quantity

Wood Finishes

- RCL Royal Cherry
- LWL Light Walnut
- ESP Espresso
- MHL Mahogany
- SMK Smoke
- CML Clear Maple
- COL Clear Oak
- CHY Cherry
- AMB Amber
- BLK Black

Graded-In Fabric | Leather

Specific grades for fabrics and leathers can be found on the separate grade cards found in your Taylor binder. For fabric and leather patterns not graded-in, please contact Customer Service for pricing.

Dimensions

Dimensions listed in this price book are in inches and approximate.

Freight

Zone list pricing includes freight prepaid by Taylor for delivery to one destination only within the zone. See pg. 5 for details.

Large Order Freight Discount

For orders with 20 units or more, please contact Customer Service for pricing.

Minimum Prepaid Freight Charges

Orders with **5 or less chairs** (in any combination of guest, swivel, lounge, etc.) will be charged **\$195 list per order**.

5 | 15

Five Rooms in Fifteen Days

Seating marked with this logo is a part of Taylor's "Five Rooms in Fifteen Days" program. Refer to page 11 for details.

Model	Dimensions	Zone	COM	A	B	C	D	COL	L1	L2	L3	
9930COS Cosmo	Width	26¾"	Will Call	1270	1750	2075	2395	2965	1750	2235	2555	2965
	Depth	33"	Zone 1	1460	1940	2265	2585	3155	1940	2425	2745	3155
	Height	33"	Zone 2	1495	1975	2300	2620	3190	1975	2460	2780	3190
	Seat Height	19"	Zone 3	1500	1980	2305	2625	3195	1980	2465	2785	3195
	Seat Depth	21½"	Zone 4	1510	1990	2315	2635	3205	1990	2475	2795	3205
	Arm Height	25"										
	Width/B Arms	22"										
	COM	4 yds.										
	COL	54 sq. ft.										
	Weight	54 lbs.										

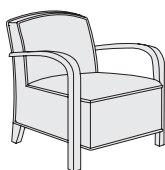

Product Notes:

Optional contrasting welts - **add \$95 list**, please specify. Available in all Taylor finishes.

Model	Dimensions	Zone	COM	A	B	C	D	COL	L1	L2	L3	
9954COS Cosmo	Width	49¾"	Will Call	1775	2435	2870	3305	4145	2435	3090	3525	4145
	Depth	33"	Zone 1	2050	2710	3145	3580	4420	2710	3365	3800	4420
	Height	33"	Zone 2	2080	2740	3175	3610	4450	2740	3395	3830	4450
	Seat Height	19"	Zone 3	2090	2750	3185	3620	4460	2750	3405	3840	4460
	Seat Depth	21½"	Zone 4	2100	2760	3195	3630	4470	2760	3415	3850	4470
	Arm Height	25"										
	Width/B Arms	44½"										
	COM	7½ yds.										
	COL	102 sq. ft.										
	Weight	86 lbs.										

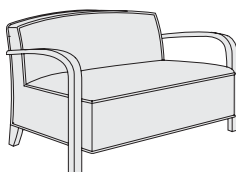

Product Notes:

Optional contrasting welts - **add \$125 list**, please specify. Available in all Taylor finishes.



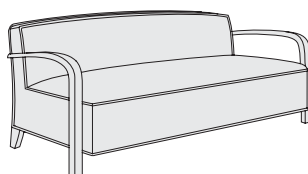

Model	Dimensions	Zone	COM	A	B	C	D	COL	L1	L2	L3	
9974COS Cosmo	Width	71¾"	Will Call	2240	3100	3670	4240	5385	3100	3955	4530	5385
	Depth	33"	Zone 1	2580	3440	4010	4580	5725	3440	4295	4870	5725
	Height	33"	Zone 2	2615	3475	4045	4615	5760	3475	4330	4905	5760
	Seat Height	19"	Zone 3	2625	3485	4055	4625	5770	3485	4340	4915	5770
	Seat Depth	21½"	Zone 4	2635	3495	4065	4635	5780	3495	4350	4925	5780
	Arm Height	25"										
	Width/B Arms	66½"										
	COM	11 yds.										
	COL	149 sq. ft.										
	Weight	115 lbs.										





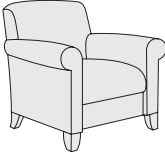

Product Notes:

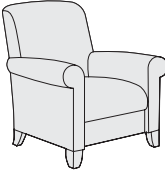

Optional contrasting welts - **add \$150 list**, please specify. Available in all Taylor finishes.



LOUNGE & MULTIPLE

Model	Dimensions	Zone	COM	A	B	C	D	COL	L1	L2	L3		
9930MAX Maxwell	 Width 33" Depth 33" Height 34" Seat Height 19" Seat Depth 21½" Arm Height 26" Width/B Arms 21½" COM 7½ yds. COL 102 sq. ft. Weight 73 lbs.	Will Call	1475	1945	2255	2575	3490	1945	2410	2750	3490		
		Zone 1	1665	2135	2445	2765	3680	2135	2600	2940	3680		
		Zone 2	1700	2170	2480	2800	3715	2170	2635	2975	3715		
		Zone 3	1705	2175	2485	2805	3720	2175	2640	2980	3720		
		Zone 4	1715	2185	2495	2815	3730	2185	2650	2990	3730		
													
		Product Notes:  Optional metal leg with satin nickel finish - add \$50 list , please specify (-ML).  Optional casters in lieu of rear legs (includes handle mounted on outside back) - add \$60 list , please specify (-CAS).  Optional wood pivoting tablet arm with right sitting position - add \$225 list , please specify (-TAB). Standard wood leg and optional pivoting tablet arm available in all Taylor finishes.											

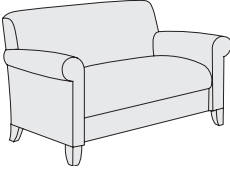
9931MAX Maxwell	Width 33" Depth 33" Height 39" Seat Height 19" Seat Depth 21½" Arm Height 26" Width/B Arms 21½" COM 8 yds. COL 108 sq. ft. Weight 75 lbs.	Will Call	1590	2060	2370	2690	3605	2060	2525	2865	3605		
		Zone 1	1780	2250	2560	2880	3795	2250	2715	3055	3795		
		Zone 2	1815	2285	2595	2915	3830	2285	2750	3090	3830		
		Zone 3	1820	2290	2600	2920	3835	2290	2755	3095	3835		
		Zone 4	1830	2300	2610	2930	3845	2300	2765	3105	3845		
													
		Product Notes:  Optional metal leg with satin nickel finish - add \$50 list , please specify (-ML).  Optional casters in lieu of rear legs (includes handle mounted on outside back) - add \$60 list , please specify (-CAS).  Optional wood pivoting tablet arm with right sitting position - add \$225 list , please specify (-TAB). Standard wood leg and optional pivoting tablet arm available in all Taylor finishes.											

High Back

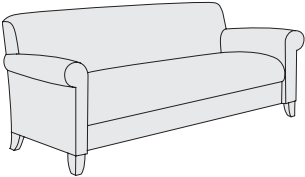
9954MAX Maxwell	Width 56" Depth 33" Height 34" Seat Height 19" Seat Depth 21½" Arm Height 26" Width/B Arms 44" COM 9½ yds. COL 130 sq. ft. Weight 112 lbs.	Will Call	1995	2620	3035	3450	4575	2620	3245	3660	4575		
		Zone 1	2270	2895	3310	3725	4850	2895	3520	3935	4850		
		Zone 2	2300	2925	3340	3755	4880	2925	3550	3965	4880		
		Zone 3	2310	2935	3350	3765	4890	2935	3560	3975	4890		
		Zone 4	2320	2945	3360	3775	4900	2945	3570	3985	4900		
													
		Product Notes:  Optional metal leg with satin nickel finish - add \$50 list , please specify (-ML).  Optional wood pivoting tablet arm with right sitting position - add \$225 list , please specify (-TAB). Standard wood leg and optional pivoting tablet arm available in all Taylor finishes.											

9974MAX Maxwell	Width 78" Depth 33" Height 34" Seat Height 19" Seat Depth 21½" Arm Height 26" Width/B Arms 66" COM 13 yds. COL 170 sq. ft. Weight 137 lbs.	Will Call	2480	3305	3855	4405	5850	3305	4135	4715	5850		
		Zone 1	2820	3645	4195	4745	6190	3645	4475	5055	6190		
		Zone 2	2855	3680	4230	4780	6225	3680	4510	5090	6225		
		Zone 3	2865	3690	4240	4790	6235	3690	4520	5100	6235		
		Zone 4	2875	3700	4250	4800	6245	3700	4530	5110	6245		
													
		Product Notes:  Optional metal leg with satin nickel finish - add \$50 list , please specify (-ML).  Optional wood pivoting tablet arm with right sitting position - add \$225 list , please specify (-TAB). Standard wood leg and optional pivoting tablet arm available in all Taylor finishes.											

LOUNGE & MULTIPLE

To specify, include:

- Model Number
- Wood Finish
- Fabric | Leather
- Quantity

Wood Finishes

- RCL Royal Cherry
- LWL Light Walnut
- ESP Espresso
- MHL Mahogany
- SMK Smoke
- CML Clear Maple
- COL Clear Oak
- CHY Cherry
- AMB Amber
- BLK Black

Graded-In Fabric | Leather

Specific grades for fabrics and leathers can be found on the separate grade cards found in your Taylor binder. For fabric and leather patterns not graded-in, please contact Customer Service for pricing.

Dimensions

Dimensions listed in this price book are in inches and approximate.

Freight

Zone list pricing includes freight prepaid by Taylor for delivery to one destination only within the zone. See pg. 5 for details.

Large Order Freight Discount

For orders with 20 units or more, please contact Customer Service for pricing.

Minimum Prepaid Freight Charges

Orders with **5 or less chairs** (in any combination of guest, swivel, lounge, etc.) will be charged **\$195 list per order**.

5 | 15

Five Rooms in Fifteen Days

Seating marked with this logo is a part of Taylor's "Five Rooms in Fifteen Days" program. Refer to page 11 for details.

Model	Dimensions	Zone	COM	A	B	C	D	COL	L1	L2	L3	
9930MET Metro	Width	31½"	Will Call	1475	1945	2255	2575	3490	1945	2410	2750	3490
	Depth	33"	Zone 1	1665	2135	2445	2765	3680	2135	2600	2940	3680
	Height	32½"	Zone 2	1700	2170	2480	2800	3715	2170	2635	2975	3715
	Seat Height	19"	Zone 3	1705	2175	2485	2805	3720	2175	2640	2980	3720
	Seat Depth	21½"	Zone 4	1715	2185	2495	2815	3730	2185	2650	2990	3730
	Arm Height	26¼"										
	Width/B Arms	21½"										
	COM	7 yds.										
	COL	95 sq. ft.										
	Weight	66 lbs.										

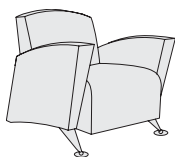

5 | 15

Two-Tone COM/COL*

- COM (Arms - Inside & Outside) 3¾ yds.
- COM (Body - Seat & Back) 3½ yds.
- COL (Arms - Inside & Outside) 52 sq. ft.
- COL (Body - Seat & Back) 47 sq. ft.



Product Notes:

Optional casters in lieu of front legs (includes handle mounted on outside back) - **add \$60 list**, please specify (-CAS).



Optional wood pivoting tablet arm with right sitting position - **add \$225 list**, please specify (-TAB). Available in all Taylor finishes.

*Two-tone upholstery applications will be priced at the higher of the two price grades. If two fabrics from the same price grade are used, item will be priced at the next higher price grade. If two COMs are used, item will be priced at the COL price grade.

Model	Dimensions	Zone	COM	A	B	C	D	COL	L1	L2	L3	
9954MET Metro	Width	53"	Will Call	1995	2620	3035	3450	4575	2620	3245	3660	4575
	Depth	33"	Zone 1	2270	2895	3310	3725	4850	2895	3520	3935	4850
	Height	32½"	Zone 2	2300	2925	3340	3755	4880	2925	3550	3965	4880
	Seat Height	19"	Zone 3	2310	2935	3350	3765	4890	2935	3560	3975	4890
	Seat Depth	22"	Zone 4	2320	2945	3360	3775	4900	2945	3570	3985	4900
	Arm Height	26¼"										
	Width/B Arms	44"										
	COM	9 yds.										
	COL	120 sq. ft.										
	Weight	105 lbs.										

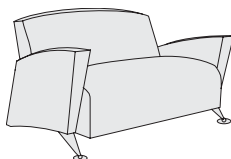

Two-Tone COM/COL*

- COM (Arms - Inside & Outside) 3¾ yds.
- COM (Body - Seat & Back) 5½ yds.
- COL (Arms - Inside & Outside) 52 sq. ft.
- COL (Body - Seat & Back) 74 sq. ft.



Product Notes:

Optional wood pivoting tablet arm with right sitting position - **add \$225 list**, please specify (-TAB). Available in all Taylor finishes.

*Two-tone upholstery applications will be priced at the higher of the two price grades. If two fabrics from the same price grade are used, item will be priced at the next higher price grade. If two COMs are used, item will be priced at the COL price grade.

Model	Dimensions	Zone	COM	A	B	C	D	COL	L1	L2	L3	
9974MET Metro	Width	75"	Will Call	2480	3305	3855	4405	5850	3305	4135	4715	5850
	Depth	33"	Zone 1	2820	3645	4195	4745	6190	3645	4475	5055	6190
	Height	32½"	Zone 2	2855	3680	4230	4780	6225	3680	4510	5090	6225
	Seat Height	19"	Zone 3	2865	3690	4240	4790	6235	3690	4520	5100	6235
	Seat Depth	22"	Zone 4	2875	3700	4250	4800	6245	3700	4530	5110	6245
	Arm Height	26¼"										
	Width/B Arms	66"										
	COM	12½ yds.										
	COL	175 sq. ft.										
	Weight	131 lbs.										

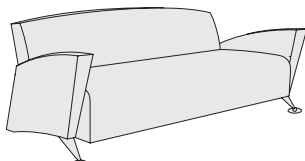

Two-Tone COM/COL*

- COM (Arms - Inside & Outside) 3¾ yds.
- COM (Body - Seat & Back) 9 yds.
- COL (Arms - Inside & Outside) 52 sq. ft.
- COL (Body - Seat & Back) 123 sq. ft.



Product Notes:

Optional wood pivoting tablet arm with right sitting position - **add \$225 list**, please specify (-TAB). Available in all Taylor finishes.

*Two-tone upholstery applications will be priced at the higher of the two price grades. If two fabrics from the same price grade are used, item will be priced at the next higher price grade. If two COMs are used, item will be priced at the COL price grade.

To specify, include:

- Model Number
- Wood Finish
- Fabric | Leather
- Quantity

Wood Finishes

- **RCL** Royal Cherry
- **LWL** Light Walnut
- **ESP** Espresso
- **MHL** Mahogany
- **SMK** Smoke
- **CML** Clear Maple
- **COL** Clear Oak
- **CHY** Cherry
- **AMB** Amber
- **BLK** Black

Graded-In Fabric | Leather

Specific grades for fabrics and leathers can be found on the separate grade cards found in your Taylor binder. For fabric and leather patterns not graded-in, please contact Customer Service for pricing.

Dimensions

Dimensions listed in this price book are in inches and approximate.

Freight

Zone list pricing includes freight prepaid by Taylor for delivery to one destination only within the zone. See pg. 5 for details.

Large Order Freight Discount

For orders with 20 units or more, please contact Customer Service for pricing.

Minimum Prepaid Freight Charges

Orders with **5 or less chairs** (in any combination of guest, swivel, lounge, etc.) will be charged **\$195 list per order**.

5 | 15

Five Rooms in Fifteen Days

Seating marked with this logo is a part of Taylor's "Five Rooms in Fifteen Days" program. Refer to page 11 for details.

Model	Dimensions	Zone	COM	A	B	C	D	COL	L1	L2	L3	
9930SAV Savannah	Width	29½"	Will Call	1475	1945	2255	2575	3490	1945	2410	2750	3490
	Depth	33"	Zone 1	1665	2135	2445	2765	3680	2135	2600	2940	3680
	Height	34"	Zone 2	1700	2170	2480	2800	3715	2170	2635	2975	3715
	Seat Height	19"	Zone 3	1705	2175	2485	2805	3720	2175	2640	2980	3720
	Seat Depth	21½"	Zone 4	1715	2185	2495	2815	3730	2185	2650	2990	3730
	Arm Height	26"										
	Width/B Arms	21½"										
COM	7½ yds.											
COL	102 sq. ft.											
Weight	86 lbs.											

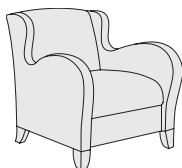

Product Notes:

Optional metal leg with satin nickel finish - **add \$50 list**, please specify **(-ML)**.



Optional casters in lieu of rear legs (includes handle mounted on outside back) - **add \$60 list**, please specify **(-CAS)**.



Optional wood pivoting tablet arm with right sitting position - **add \$225 list**, please specify **(-TAB)**.

Standard wood leg and optional pivoting tablet arm available in all Taylor finishes.

9954SAV Savannah	Width	51½"	Zone	COM	A	B	C	D	COL	L1	L2	L3
	Depth	33"	Will Call	1995	2620	3035	3450	4575	2620	3245	3660	4575
	Height	34"	Zone 1	2270	2895	3310	3725	4850	2895	3520	3935	4850
	Seat Height	19"	Zone 2	2300	2925	3340	3755	4880	2925	3550	3965	4880
	Seat Depth	21½"	Zone 3	2310	2935	3350	3765	4890	2935	3560	3975	4890
	Arm Height	26"	Zone 4	2320	2945	3360	3775	4900	2945	3570	3985	4900
	Width/B Arms	44"										
COM	9¾ yds.											
COL	133 sq. ft.											
Weight	124 lbs.											

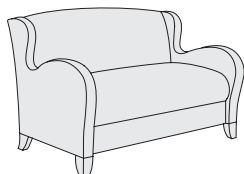

Product Notes

Optional metal leg with satin nickel finish - **add \$50 list**, please specify **(-ML)**.



Optional wood pivoting tablet arm with right sitting position - **add \$225 list**, please specify **(-TAB)**.

Standard wood leg and optional pivoting tablet arm available in all Taylor finishes.

9974SAV Savannah	Width	73½"	Zone	COM	A	B	C	D	COL	L1	L2	L3
	Depth	33"	Will Call	2480	3305	3855	4405	5850	3305	4135	4715	5850
	Height	34"	Zone 1	2820	3645	4195	4745	6190	3645	4475	5055	6190
	Seat Height	19"	Zone 2	2855	3680	4230	4780	6225	3680	4510	5090	6225
	Seat Depth	21½"	Zone 3	2865	3690	4240	4790	6235	3690	4520	5100	6235
	Arm Height	26"	Zone 4	2875	3700	4250	4800	6245	3700	4530	5110	6245
	Width/B Arms	66"										
COM	13 yds.											
COL	177 sq. ft.											
Weight	149 lbs.											

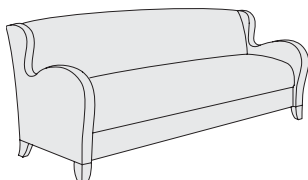

Product Notes

Optional metal leg with satin nickel finish - **add \$50 list**, please specify **(-ML)**.



Optional wood pivoting tablet arm with right sitting position - **add \$225 list**, please specify **(-TAB)**.

Standard wood leg and optional pivoting tablet arm available in all Taylor finishes.

LOUNGE & MULTIPLE

To specify, include:

- Model Number
- Wood Finish
- Fabric | Leather
- Quantity

Wood Finishes

- RCL Royal Cherry
- LWL Light Walnut
- ESP Espresso
- MHL Mahogany
- SMK Smoke
- CML Clear Maple
- COL Clear Oak
- CHY Cherry
- AMB Amber
- BLK Black

Graded-In Fabric | Leather

Specific grades for fabrics and leathers can be found on the separate grade cards found in your Taylor binder. For fabric and leather patterns not graded-in, please contact Customer Service for pricing.

Dimensions

Dimensions listed in this price book are in inches and approximate.

Freight

Zone list pricing includes freight prepaid by Taylor for delivery to one destination only within the zone. See pg. 5 for details.

Large Order Freight Discount

For orders with 20 units or more, please contact Customer Service for pricing.

Minimum Prepaid Freight Charges

Orders with **5 or less chairs** (in any combination of guest, swivel, lounge, etc.) will be charged **\$195 list per order**.

5 | 15

Five Rooms in Fifteen Days

Seating marked with this logo is a part of Taylor's "Five Rooms in Fifteen Days" program. Refer to page 11 for details.

Model	Dimensions	Zone	COM	A	B	C	D	COL	L1	L2	L3	
9930SLB Shelby	Width	31"	Will Call	1475	1945	2255	2575	3490	1945	2410	2750	3490
	Depth	33"	Zone 1	1665	2135	2445	2765	3680	2135	2600	2940	3680
	Height	34"	Zone 2	1700	2170	2480	2800	3715	2170	2635	2975	3715
	Seat Height	19"	Zone 3	1705	2175	2485	2805	3720	2175	2640	2980	3720
	Seat Depth	21½"	Zone 4	1715	2185	2495	2815	3730	2185	2650	2990	3730
	Arm Height	26¼"										
	Width/B Arms	21½"										
	COM	7 yds.										
	COL	95 sq. ft.										
	Weight	70 lbs.										

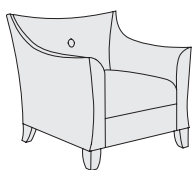

- Product Notes:**
- Optional metal leg with satin nickel finish - **add \$50 list**, please specify **(-ML)**.
 - Optional casters in lieu of rear legs (includes handle mounted on outside back) - **add \$60 list**, please specify **(-CAS)**.
 - Optional wood pivoting tablet arm with right sitting position - **add \$225 list**, please specify **(-TAB)**.
- Standard wood leg and optional pivoting tablet arm available in all Taylor finishes.

Model	Dimensions	Zone	COM	A	B	C	D	COL	L1	L2	L3	
9954SLB Shelby	Width	53"	Will Call	1995	2620	3035	3450	4575	2620	3245	3660	4575
	Depth	33"	Zone 1	2270	2895	3310	3725	4850	2895	3520	3935	4850
	Height	34"	Zone 2	2300	2925	3340	3755	4880	2925	3550	3965	4880
	Seat Height	19"	Zone 3	2310	2935	3350	3765	4890	2935	3560	3975	4890
	Seat Depth	21½"	Zone 4	2320	2945	3360	3775	4900	2945	3570	3985	4900
	Arm Height	26¼"										
	Width/B Arms	44"										
	COM	9 yds.										
	COL	135 sq. ft.										
	Weight	97 lbs.										

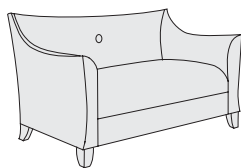

- Product Notes:**
- Optional metal leg with satin nickel finish - **add \$50 list**, please specify **(-ML)**.
 - Optional wood pivoting tablet arm with right sitting position - **add \$225 list**, please specify **(-TAB)**.
- Standard wood leg and optional pivoting tablet arm available in all Taylor finishes.

Model	Dimensions	Zone	COM	A	B	C	D	COL	L1	L2	L3	
9974SLB Shelby	Width	75"	Will Call	2480	3305	3855	4405	5850	3305	4135	4715	5850
	Depth	33"	Zone 1	2820	3645	4195	4745	6190	3645	4475	5055	6190
	Height	34"	Zone 2	2855	3680	4230	4780	6225	3680	4510	5090	6225
	Seat Height	19"	Zone 3	2865	3690	4240	4790	6235	3690	4520	5100	6235
	Seat Depth	21½"	Zone 4	2875	3700	4250	4800	6245	3700	4530	5110	6245
	Arm Height	26¼"										
	Width/B Arms	66"										
	COM	11½ yds.										
	COL	160 sq. ft.										
	Weight	132 lbs.										

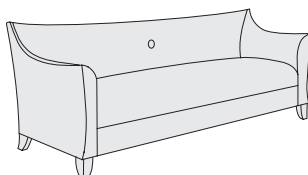

- Product Notes:**
- Optional metal leg with satin nickel finish - **add \$50 list**, please specify **(-ML)**.
 - Optional wood pivoting tablet arm with right sitting position - **add \$225 list**, please specify **(-TAB)**.
- Standard wood leg and optional pivoting tablet arm available in all Taylor finishes.

LOUNGE & MULTIPLE

MULTIPLE SEATING & TABLES

How to Specify

Zoe Multiple Seating configurations must be ordered according to the model number, as well as the position of the chairs and/or connecting tables.

Zoe seat units are available in 1-3 seat versions and are shipped up to three seating units per carton.

Tables for Zoe Multiple Seating may be specified to join with seating units for multiple configuration possibilities. All tables are shipped unattached to seat units with brackets attached to the tables. A screwdriver is required for onsite assembly.

Please use the drawings below as a guideline when specifying and ordering Zoe Multiple Seating. **Chair and table model numbers should be specified left to right.**

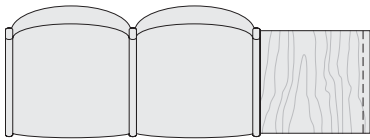

Square End Table

Specify left to right:
2111-2S | SQ-ET

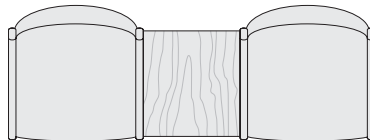

Square Middle Table

Specify left to right:
2111 | SQ-MT | 2111

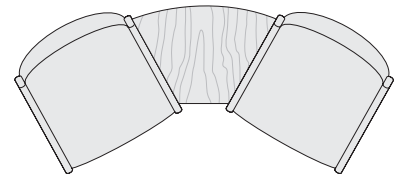

Curved Middle Table

Specify left to right:
2111 | CV-MT | 2111

Specifying Corner Tables

When specifying corner tables for Zoe Multiple Seating, you **must allow additional space to accommodate the entire depth of the seating unit**. This allowance is necessary because tables are attached underneath the side rail, which is not the overall depth of the chair. Please see drawings below for specification details.

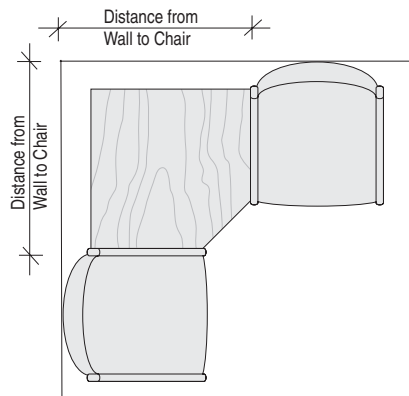
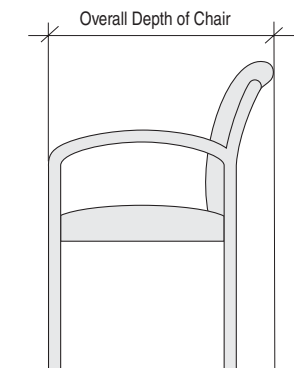

Square Corner Table

Specify left to right:
2111 | SQ-CT | 2111

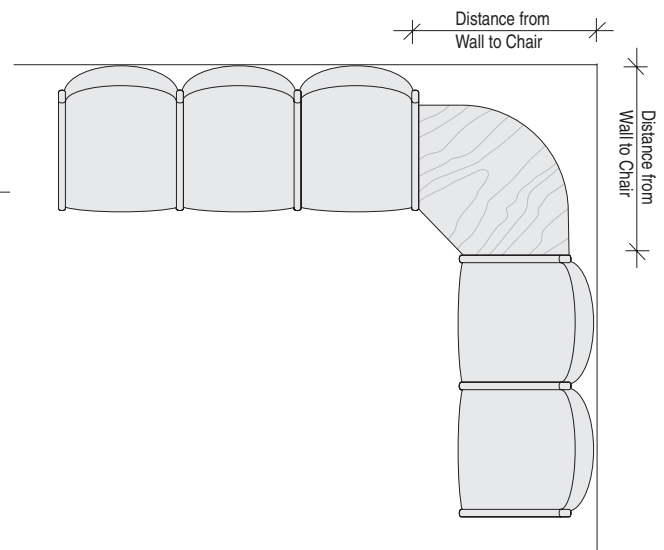

Curved Middle Table

Specify left to right:
2111-3S | CV-CT | 2111-2S

To specify, include:

- Model Number
- Wood Finish
- Fabric | Leather
- Quantity

Wood Finishes

- RCL Royal Cherry
- LWL Light Walnut
- ESP Espresso
- MHL Mahogany
- SMK Smoke
- CML Clear Maple
- COL Clear Oak
- CHY Cherry
- AMB Amber
- BLK Black

Graded-In Fabric | Leather

Specific grades for fabrics and leathers can be found on the separate grade cards found in your Taylor binder. For fabric and leather patterns not graded-in, please contact Customer Service for pricing.

Dimensions

Dimensions listed in this price book are in inches and approximate.

Freight

Zone list pricing includes freight prepaid by Taylor for delivery to one destination only within the zone. See pg. 5 for details.

Large Order Freight Discount

For orders with 20 units or more, please contact Customer Service for pricing.

Minimum Prepaid Freight Charges

Orders with 5 or less chairs (in any combination of guest, swivel, lounge, etc.) will be charged \$195 list per order.

5|15

Five Rooms in Fifteen Days

Seating marked with this logo is a part of Taylor's "Five Rooms in Fifteen Days" program. Refer to page 11 for details.

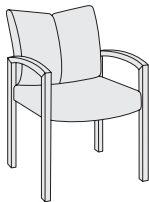
Model	Dimensions	Zone	COM	A	B	C	D	COL	L1	L2	L3		
2111 Zoe  Closed Back	5 15 Width 23" Depth 25½" Height 34½" Seat Height 18" Seat Depth 19¼" Arm Height 25¾" Width/B Arms 20" COM 2¼ yds. COL 31 sq. ft. Weight 39 lbs.	Will Call	720	845	950	1055	1305	845	1005	1105	1305		
		Zone 1	805	930	1035	1140	1390	930	1090	1190	1390		
		Zone 2	815	940	1045	1150	1400	940	1100	1200	1400		
		Zone 3	820	945	1050	1155	1405	945	1105	1205	1405		
		Zone 4	830	955	1060	1165	1415	955	1115	1215	1415		
		Product Notes:											
		Optional sled base - add \$60 list , please specify.											
		Available in all Taylor finishes.											
		Two-Tone COM/COL*											
		COM (Outside Back) 1 yd.											
COM (Inside Back/Seat) 1¾ yds.													
COL (Outside Back) 14 sq. ft.													
COL (Inside Back/Seat) 24 sq. ft.													

Product Notes:

Optional sled base - add \$60 list, please specify. Available in all Taylor finishes.

*Two-tone upholstery applications will be priced at the higher of the two price grades.

If two fabrics from the same price grade are used, item will be priced at the next higher price grade. If two COMs are used, item will be priced at the COL price grade.

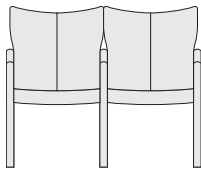
Model	Dimensions	Zone	COM	A	B	C	D	COL	L1	L2	L3		
2111-2S Zoe Multiple  Two Seat Multiple, Closed Back	Width 44¾" Depth 25½" Height 34½" Seat Height 18" Seat Depth 19¼" Arm Height 25¾" Width/B Arms 20" COM 4½ yds. COL 62 sq. ft. Weight 68 lbs.	Will Call	1270	1550	1735	1935	2475	1550	1830	2065	2475		
		Zone 1	1460	1740	1925	2125	2665	1740	2020	2255	2665		
		Zone 2	1495	1775	1960	2160	2700	1775	2055	2290	2700		
		Zone 3	1500	1780	1965	2165	2705	1780	2060	2295	2705		
		Zone 4	1510	1790	1975	2175	2715	1790	2070	2305	2715		
		Product Notes:											
		Optional sled base - add \$90 list , please specify.											
		Available in all Taylor finishes.											
		Two-Tone COM/COL*											
		COM (Outside Back) 1 yd.											
COM (Inside Back/Seat) 3½ yds.													
COL (Outside Back) 14 sq. ft.													
COL (Inside Back/Seat) 48 sq. ft.													

Product Notes:

Optional sled base - add \$90 list, please specify. Available in all Taylor finishes.

*Two-tone upholstery applications will be priced at the higher of the two price grades.

If two fabrics from the same price grade are used, item will be priced at the next higher price grade. If two COMs are used, item will be priced at the COL price grade.

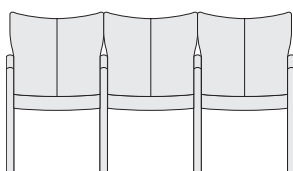
Model	Dimensions	Zone	COM	A	B	C	D	COL	L1	L2	L3		
2111-3S Zoe Multiple  Three Seat Multiple, Closed Back	Width 66½" Depth 25½" Height 34½" Seat Height 18" Seat Depth 19¼" Arm Height 25¾" Width/B Arms 20" COM 6¾ yds. COL 93 sq. ft. Weight 91 lbs.	Will Call	1845	2265	2545	2805	3575	2265	2685	2965	3575		
		Zone 1	2035	2455	2735	2995	3765	2455	2875	3155	3765		
		Zone 2	2070	2490	2770	3030	3800	2490	2910	3190	3800		
		Zone 3	2075	2495	2775	3035	3805	2495	2915	3195	3805		
		Zone 4	2085	2505	2785	3045	3815	2505	2925	3205	3815		
		Product Notes:											
		Optional sled base - add \$120 list , please specify.											
		Available in all Taylor finishes.											
		Two-Tone COM/COL*											
		COM (Outside Back) 2 yd.											
COM (Inside Back/Seat) 5¼ yds.													
COL (Outside Back) 27 sq. ft.													
COL (Inside Back/Seat) 72 sq. ft.													

Product Notes:

Optional sled base - add \$120 list, please specify. Available in all Taylor finishes.

*Two-tone upholstery applications will be priced at the higher of the two price grades.

If two fabrics from the same price grade are used, item will be priced at the next higher price grade. If two COMs are used, item will be priced at the COL price grade.

To specify, include:

- Model Number
- Wood Finish
- Fabric | Leather
- Quantity

Wood Finishes

- RCL Royal Cherry
- LWL Light Walnut
- ESP Espresso
- MHL Mahogany
- SMK Smoke
- CML Clear Maple
- COL Clear Oak
- CHY Cherry
- AMB Amber
- BLK Black

Graded-In Fabric | Leather

Specific grades for fabrics and leathers can be found on the separate grade cards found in your Taylor binder. For fabric and leather patterns not graded-in, please contact Customer Service for pricing.

Dimensions

Dimensions listed in this price book are in inches and approximate.

Freight

Zone list pricing includes freight prepaid by Taylor for delivery to one destination only within the zone. See pg. 5 for details.

Large Order Freight Discount

For orders with 20 units or more, please contact Customer Service for pricing.

Minimum Prepaid Freight Charges

Orders with **5 or less chairs** (in any combination of guest, swivel, lounge, etc.) will be charged **\$195 list per order**.

5 | 15

Five Rooms in Fifteen Days

Seating marked with this logo is a part of Taylor's "Five Rooms in Fifteen Days" program. Refer to page 11 for details.

Model	Dimensions	Zone	COM	A	B	C	D	COL	L1	L2	L3	
2112 Zoe	Width	23"	Will Call	720	845	950	1055	1305	845	1005	1105	1305
	Depth	25½"	Zone 1	805	930	1035	1140	1390	930	1090	1190	1390
	Height	34½"	Zone 2	815	940	1045	1150	1400	940	1100	1200	1400
	Seat Height	18"	Zone 3	820	945	1050	1155	1405	945	1105	1205	1405
	Seat Depth	19¼"	Zone 4	830	955	1060	1165	1415	955	1115	1215	1415
	Arm Height	25¾"										
	Width/B Arms	20"										
	COM	2¼ yds.										
	COL	31 sq. ft.										
	Weight	39 lbs.										
Two-Tone COM/COL*												
COM (Outside Back)		1 yd.										
COM (Inside Back/Seat)		1¾ yds.										
COL (Outside Back)		14 sq. ft.										
COL (Inside Back/Seat)		24 sq. ft.										

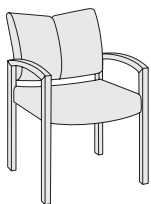

Open Back

Product Notes:

Optional sled base - **add \$60 list**, please specify. Available in all Taylor finishes.

***Two-tone upholstery applications will be priced at the higher of the two price grades.**

If two fabrics from the same price grade are used, item will be priced at the next higher price grade. If two COMs are used, item will be priced at the COL price grade.

Model	Dimensions	Zone	COM	A	B	C	D	COL	L1	L2	L3	
2112-2S Zoe Multiple	Width	44¾"	Will Call	1270	1550	1735	1935	2475	1550	1830	2065	2475
	Depth	25½"	Zone 1	1460	1740	1925	2125	2665	1740	2020	2255	2665
	Height	34½"	Zone 2	1495	1775	1960	2160	2700	1775	2055	2290	2700
	Seat Height	18"	Zone 3	1500	1780	1965	2165	2705	1780	2060	2295	2705
	Seat Depth	19¼"	Zone 4	1510	1790	1975	2175	2715	1790	2070	2305	2715
	Arm Height	25¾"										
	Width/B Arms	20"										
	COM	4½ yds.										
	COL	62 sq. ft.										
	Weight	68 lbs.										
Two-Tone COM/COL*												
COM (Outside Back)		1 yd.										
COM (Inside Back/Seat)		3½ yds.										
COL (Outside Back)		14 sq. ft.										
COL (Inside Back/Seat)		48 sq. ft.										

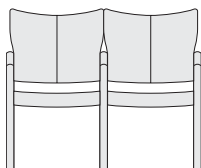

Two Seat Multiple, Open Back

Product Notes:

Optional sled base - **add \$90 list**, please specify. Available in all Taylor finishes.

***Two-tone upholstery applications will be priced at the higher of the two price grades.**

If two fabrics from the same price grade are used, item will be priced at the next higher price grade. If two COMs are used, item will be priced at the COL price grade.

Model	Dimensions	Zone	COM	A	B	C	D	COL	L1	L2	L3	
2112-3S Zoe Multiple	Width	66½"	Will Call	1845	2265	2545	2805	3575	2265	2685	2965	3575
	Depth	25½"	Zone 1	2035	2455	2735	2995	3765	2455	2875	3155	3765
	Height	34½"	Zone 2	2070	2490	2770	3030	3800	2490	2910	3190	3800
	Seat Height	18"	Zone 3	2075	2495	2775	3035	3805	2495	2915	3195	3805
	Seat Depth	19¼"	Zone 4	2085	2505	2785	3045	3815	2505	2925	3205	3815
	Arm Height	25¾"										
	Width/B Arms	20"										
	COM	6¾ yds.										
	COL	93 sq. ft.										
	Weight	91 lbs.										
Two-Tone COM/COL*												
COM (Outside Back)		2 yd.										
COM (Inside Back/Seat)		5¼ yds.										
COL (Outside Back)		27 sq. ft.										
COL (Inside Back/Seat)		72 sq. ft.										

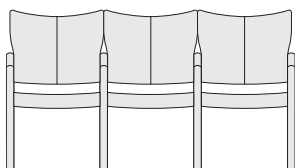

Three Seat Multiple, Open Back

Product Notes:

Optional sled base - **add \$120 list**, please specify. Available in all Taylor finishes.

***Two-tone upholstery applications will be priced at the higher of the two price grades.**

If two fabrics from the same price grade are used, item will be priced at the next higher price grade. If two COMs are used, item will be priced at the COL price grade.

LOUNGE & MULTIPLE

Model	Dimensions		Zone	List Price
-------	------------	--	------	------------

SQ-CT
Zoe Multiple

Width	30½"
Depth	30½"
Weight	42 lbs.

Will Call	570
Zone 1	590
Zone 2	605
Zone 3	625
Zone 4	635

Product Notes:
Brackets for attachment are included.
Available in all Taylor finishes.

For layout with a corner table, allow 34½" actual space to accommodate chair attachment (see page 81 for diagram).

For tables shipping via UPS, please add the following surcharges to the list price per table: **+\$75 list (Zone 1 & 2); +\$125 list (Zone 3 & 4).**

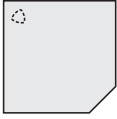

Square Corner Table

SQ-MT
Zoe Multiple

Width	19½"
Depth	19½"
Weight	26 lbs.

Will Call	365
Zone 1	380
Zone 2	390
Zone 3	400
Zone 4	410

Product Notes:
Brackets for attachment are included.
Available in all Taylor finishes.

For tables shipping via UPS, please add the following surcharges to the list price per table: **+\$75 list (Zone 1 & 2); +\$125 list (Zone 3 & 4).**



Square Middle Table

SQ-ET
Zoe Multiple

Width	21¼"
Depth	19½"
Weight	28 lbs.

Will Call	620
Zone 1	645
Zone 2	655
Zone 3	675
Zone 4	690

Product Notes:
Brackets for attachment are included.
Available in all Taylor finishes.

For tables shipping via UPS, please add the following surcharges to the list price per table: **+\$75 list (Zone 1 & 2); +\$125 list (Zone 3 & 4).**

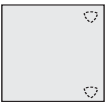

Square End Table

CV-CT
Zoe Multiple

Weight	32 lbs.
--------	---------

Will Call	620
Zone 1	645
Zone 2	655
Zone 3	675
Zone 4	690

Product Notes:
Brackets for attachment are included.
Available in all Taylor finishes.

For layout with a corner table, allow 34½" actual space to accommodate chair attachment (see page 81 for diagram).

For tables shipping via UPS, please add the following surcharges to the list price per table: **+\$75 list (Zone 1 & 2); +\$125 list (Zone 3 & 4).**

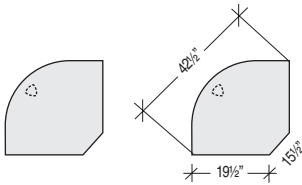

Curved Corner Table

CV-MT
Zoe Multiple

Weight	24 lbs.
--------	---------

Will Call	410
Zone 1	425
Zone 2	435
Zone 3	445
Zone 4	455

Product Notes:
Brackets for attachment are included.
Available in all Taylor finishes.

For tables shipping via UPS, please add the following surcharges to the list price per table: **+\$75 list (Zone 1 & 2); +\$125 list (Zone 3 & 4).**

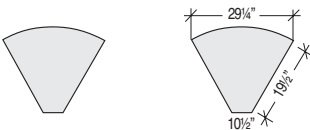

Curved Middle Table

ORBIT LOUNGE SYSTEM

How to Specify

The Orbit Lounge System is comprised of individual Seating Units, Swing Tables, Swing Arm Tables, Occasional Tables, and Ottomans. Individual seating units may be positioned to form a multitude of configurations. Because each unit is free-standing, they may be re-positioned at any time. The unique seat shapes for the middle, left, and right seating units allow endless footprint possibilities.

Orbit Lounge System configurations must be ordered according to the model number, as well as the position of the chairs and/or connecting tables. Tables are shipped unattached to seating units with all the necessary hardware included for attachment. Swing tables are available in round or triangle shape. Swing arm tables are a combination of an upholstered arm and table top surface.

Please use the drawings below as a guideline when specifying and ordering the Orbit Lounge System. Chair and table model numbers should be specified left to right. For complex configurations, it is recommended to submit a dimensioned drawing with the order.

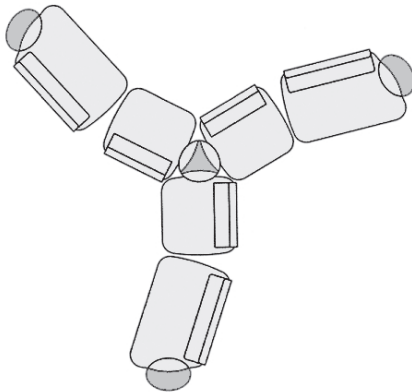

“Y” Configuration

Specify left to right:

(3) SAT-EN | (3) 2230-L | (3) 2230-M | (1) SAT-3W

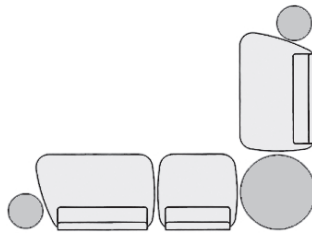

“L” Configuration

Specify left to right:

ST15R | 2230-L | 2230-M | T30R | 2230-R | ST15R

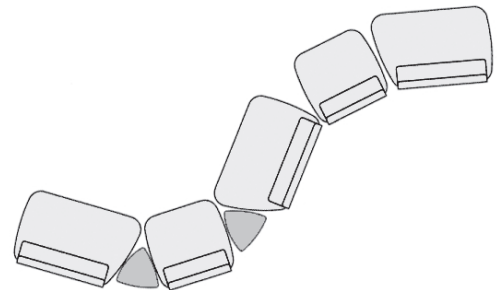

“S” Configuration

Specify left to right:

2230-R | ST15T | 2230-M | ST15T | 2230-L
| 2230-M | 2230-L

System Scaled Seating Units

System Scaled Seating Units are appropriately scaled to work in collaboration with any systems furniture configurations, including 90 and 120 degree angles. The overall depth of the system scaled seating unit is 3" shorter than the standard seating unit. Units may be incorporated inside or outside of the systems environment.

System Scaled Configuration

Specify left to right:

Inside: 2227-R | ST15R | 2227-L

Outside: (3) ST15R | (4) 2227-M

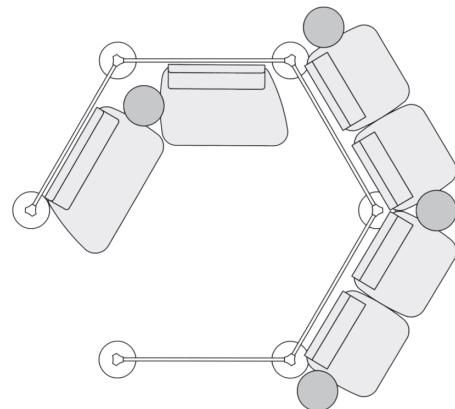

To specify, include:

- Model Number
- Wood Finish
- Fabric | Leather
- Quantity

Wood Finishes

- RCL Royal Cherry
- LWL Light Walnut
- ESP Espresso
- MHL Mahogany
- SMK Smoke
- CML Clear Maple
- COL Clear Oak
- CHY Cherry
- AMB Amber
- BLK Black

Graded-In Fabric | Leather

Specific grades for fabrics and leathers can be found on the separate grade cards found in your Taylor binder. For fabric and leather patterns not graded-in, please contact Customer Service for pricing.

Dimensions

Dimensions listed in this price book are in inches and approximate.

Freight

Zone list pricing includes freight prepaid by Taylor for delivery to one destination only within the zone. See pg. 5 for details.

Large Order Freight Discount

For orders with 20 units or more, please contact Customer Service for pricing.

Minimum Prepaid Freight Charges

Orders with 5 or less chairs (in any combination of guest, swivel, lounge, etc.) will be charged \$195 list per order.

5 | 15

Five Rooms in Fifteen Days

Seating marked with this logo is a part of Taylor's "Five Rooms in Fifteen Days" program. Refer to page 11 for details.

Model	Dimensions	Zone	COM	A	B	C	D	COL	L1	L2	L3	
2227-M Orbit	Width	32"	Will Call	1270	1705	1990	2285	2815	1705	2140	2445	2815
	Depth	27"	Zone 1	1460	1895	2180	2475	3005	1895	2330	2635	3005
	Height	32½"	Zone 2	1495	1930	2215	2510	3040	1930	2365	2670	3040
	Seat Height	18"	Zone 3	1500	1935	2220	2515	3045	1935	2370	2675	3045
	Seat Depth	21½"	Zone 4	1510	1945	2230	2525	3055	1945	2380	2685	3055
	COM	4 yds.										
	COL	54 sq. ft.										
	Weight	72 lbs.										



Middle Seating Unit, System Scaled

Two-Tone COM/COL*

- COM (Seat) 2 yd.
- COM (Back) 2 yds.
- COL (Seat) 27 sq. ft.
- COL (Back) 27 sq. ft.

Product Notes:

Optional contrasting welts - add \$65 list, please specify.

*Two-tone upholstery applications will be priced at the higher of the two price grades.

If two fabrics from the same price grade are used, item will be priced at the next higher price grade. If two COMs are used, item will be priced at the COL price grade.

Model	Dimensions	Zone	COM	A	B	C	D	COL	L1	L2	L3	
2227-L Orbit	Width	47½"	Will Call	1370	1810	2095	2390	2985	1810	2245	2545	2985
	Depth	27"	Zone 1	1645	2085	2370	2665	3260	2085	2520	2820	3260
	Height	32½"	Zone 2	1675	2115	2400	2695	3290	2115	2550	2850	3290
	Seat Height	18"	Zone 3	1685	2125	2410	2705	3300	2125	2560	2860	3300
	Seat Depth	21½"	Zone 4	1695	2135	2420	2715	3310	2135	2570	2870	3310
	COM	4½ yds.										
	COL	62 sq. ft.										
	Weight	93 lbs.										

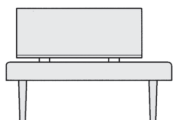

Left Seating Unit, System Scaled

Two-Tone COM/COL*

- COM (Seat) 2¼ yd.
- COM (Back) 2¼ yds.
- COL (Seat) 31 sq. ft.
- COL (Back) 31 sq. ft.

Product Notes:

Optional contrasting welts - add \$95 list, please specify.

*Two-tone upholstery applications will be priced at the higher of the two price grades.

If two fabrics from the same price grade are used, item will be priced at the next higher price grade. If two COMs are used, item will be priced at the COL price grade.

Model	Dimensions	Zone	COM	A	B	C	D	COL	L1	L2	L3	
2227-R Orbit	Width	47½"	Will Call	1370	1810	2095	2390	2985	1810	2245	2545	2985
	Depth	27"	Zone 1	1645	2085	2370	2665	3260	2085	2520	2820	3260
	Height	32½"	Zone 2	1675	2115	2400	2695	3290	2115	2550	2850	3290
	Seat Height	18"	Zone 3	1685	2125	2410	2705	3300	2125	2560	2860	3300
	Seat Depth	21½"	Zone 4	1695	2135	2420	2715	3310	2135	2570	2870	3310
	COM	4½ yds.										
	COL	62 sq. ft.										
	Weight	93 lbs.										

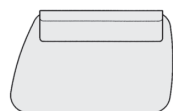

Right Seating Unit, System Scaled

Two-Tone COM/COL*

- COM (Seat) 2¼ yd.
- COM (Back) 2¼ yds.
- COL (Seat) 31 sq. ft.
- COL (Back) 31 sq. ft.

Product Notes:

Optional contrasting welts - add \$95 list, please specify.

*Two-tone upholstery applications will be priced at the higher of the two price grades.

If two fabrics from the same price grade are used, item will be priced at the next higher price grade. If two COMs are used, item will be priced at the COL price grade.

LOUNGE & MULTIPLE

To specify, include:

- Model Number
- Wood Finish
- Fabric | Leather
- Quantity

Wood Finishes

- RCL Royal Cherry
- LWL Light Walnut
- ESP Espresso
- MHL Mahogany
- SMK Smoke
- CML Clear Maple
- COL Clear Oak
- CHY Cherry
- AMB Amber
- BLK Black

Graded-In Fabric | Leather

Specific grades for fabrics and leathers can be found on the separate grade cards found in your Taylor binder. For fabric and leather patterns not graded-in, please contact Customer Service for pricing.

Dimensions

Dimensions listed in this price book are in inches and approximate.

Freight

Zone list pricing includes freight prepaid by Taylor for delivery to one destination only within the zone. See pg. 5 for details.

Large Order Freight Discount

For orders with 20 units or more, please contact Customer Service for pricing.

Minimum Prepaid Freight Charges

Orders with 5 or less chairs (in any combination of guest, swivel, lounge, etc.) will be charged \$195 list per order.

5 | 15

Five Rooms in Fifteen Days

Seating marked with this logo is a part of Taylor's "Five Rooms in Fifteen Days" program. Refer to page 11 for details.

Model	Dimensions	Zone	COM	A	B	C	D	COL	L1	L2	L3	
2230-M Orbit	Width	32"	Will Call	1370	1810	2095	2390	2985	1810	2245	2545	2985
	Depth	30"	Zone 1	1560	2000	2285	2580	3175	2000	2435	2735	3175
	Height	32½"	Zone 2	1595	2035	2320	2615	3210	2035	2470	2770	3210
	Seat Height	18"	Zone 3	1600	2040	2325	2620	3215	2040	2475	2775	3215
	Seat Depth	21½"	Zone 4	1610	2050	2335	2630	3225	2050	2485	2785	3225
	COM	4 yds.										
	COL	54 sq. ft.										
	Weight	75 lbs.										



Middle Seating Unit,
Lounge Scaled

Two-Tone COM/COL*

- COM (Seat) 2 yd.
- COM (Back) 2 yds.
- COL (Seat) 27 sq. ft.
- COL (Back) 27 sq. ft.

Product Notes:

Optional contrasting welts - add \$65 list, please specify.

*Two-tone upholstery applications will be priced at the higher of the two price grades. If two fabrics from the same price grade are used, item will be priced at the next higher price grade. If two COMs are used, item will be priced at the COL price grade.

Model	Dimensions	Zone	COM	A	B	C	D	COL	L1	L2	L3	
2230-L Orbit	Width	47½"	Will Call	1475	1915	2200	2495	3100	1915	2350	2650	3100
	Depth	30"	Zone 1	1750	2190	2475	2770	3375	2190	2625	2925	3375
	Height	32½"	Zone 2	1780	2220	2505	2800	3405	2220	2655	2955	3405
	Seat Height	18"	Zone 3	1790	2230	2515	2810	3415	2230	2665	2965	3415
	Seat Depth	21½"	Zone 4	1800	2240	2525	2820	3425	2240	2675	2975	3425
	COM	4½ yds.										
	COL	62 sq. ft.										
	Weight	95 lbs.										

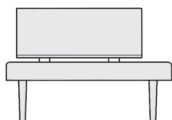

Left Seating Unit,
Lounge Scaled

Two-Tone COM/COL*

- COM (Seat) 2¼ yd.
- COM (Back) 2¼ yds.
- COL (Seat) 31 sq. ft.
- COL (Back) 31 sq. ft.

Product Notes:

Optional contrasting welts - add \$95 list, please specify.

*Two-tone upholstery applications will be priced at the higher of the two price grades. If two fabrics from the same price grade are used, item will be priced at the next higher price grade. If two COMs are used, item will be priced at the COL price grade.

Model	Dimensions	Zone	COM	A	B	C	D	COL	L1	L2	L3	
2230-R Orbit	Width	47½"	Will Call	1475	1915	2200	2495	3100	1915	2350	2650	3100
	Depth	30"	Zone 1	1750	2190	2475	2770	3375	2190	2625	2925	3375
	Height	32½"	Zone 2	1780	2220	2505	2800	3405	2220	2655	2955	3405
	Seat Height	18"	Zone 3	1790	2230	2515	2810	3415	2230	2665	2965	3415
	Seat Depth	21½"	Zone 4	1800	2240	2525	2820	3425	2240	2675	2975	3425
	COM	4½ yds.										
	COL	62 sq. ft.										
	Weight	95 lbs.										

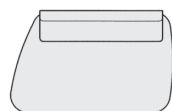
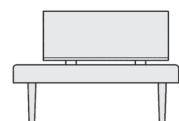

Right Seating Unit,
Lounge Scaled

Two-Tone COM/COL*

- COM (Seat) 2¼ yd.
- COM (Back) 2¼ yds.
- COL (Seat) 31 sq. ft.
- COL (Back) 31 sq. ft.

Product Notes:

Optional contrasting welts - add \$95 list, please specify.

*Two-tone upholstery applications will be priced at the higher of the two price grades. If two fabrics from the same price grade are used, item will be priced at the next higher price grade. If two COMs are used, item will be priced at the COL price grade.

LOUNGE & MULTIPLE

To specify, include:

- Model Number
- Wood Finish
- Fabric | Leather
- Quantity

Wood Finishes

- RCL Royal Cherry
- LWL Light Walnut
- ESP Espresso
- MHL Mahogany
- SMK Smoke
- CML Clear Maple
- COL Clear Oak
- CHY Cherry
- AMB Amber
- BLK Black

Graded-In Fabric | Leather

Specific grades for fabrics and leathers can be found on the separate grade cards found in your Taylor binder. For fabric and leather patterns not graded-in, please contact Customer Service for pricing.

Dimensions

Dimensions listed in this price book are in inches and approximate.

Freight

Zone list pricing includes freight prepaid by Taylor for delivery to one destination only within the zone. See pg. 5 for details.

Large Order Freight Discount

For orders with 20 units or more, please contact Customer Service for pricing.

Minimum Prepaid Freight Charges

Orders with **5 or less chairs** (in any combination of guest, swivel, lounge, etc.) will be charged **\$195 list per order**.

5 | 15

Five Rooms in Fifteen Days

Seating marked with this logo is a part of Taylor's "Five Rooms in Fifteen Days" program. Refer to page 11 for details.

Model	Dimensions	Zone	COM	A	B	C	D	COL	L1	L2	L3	
OTT-R Orbit	Width	30½" dia.	Will Call	640	775	875	950	1150	775	920	1000	1150
	Seat Height	15"	Zone 1	725	860	960	1035	1235	860	1005	1085	1235
	COM	4 yds.	Zone 2	735	870	970	1045	1245	870	1015	1095	1245
	COL	54 sq. ft.	Zone 3	740	875	975	1050	1250	875	1020	1100	1250
	Weight	33 lbs.	Zone 4	750	885	985	1060	1260	885	1030	1110	1260

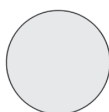

Round Ottoman

Product Notes:

Optional contrasting welts - **add \$65 list**, please specify.



Optional casters - **add \$75 list**, please specify.

Model	Dimensions	Zone	COM	A	B	C	D	COL	L1	L2	L3	
OTT-T Orbit	Width	30" x 27½"	Will Call	640	775	875	950	1150	775	920	1000	1150
	Seat Height	15"	Zone 1	725	860	960	1035	1235	860	1005	1085	1235
	COM	4 yds.	Zone 2	735	870	970	1045	1245	870	1015	1095	1245
	COL	54 sq. ft.	Zone 3	740	875	975	1050	1250	875	1020	1100	1250
	Weight	33 lbs.	Zone 4	750	885	985	1060	1260	885	1030	1110	1260



Triangle Ottoman

Product Notes:

Optional contrasting welts - **add \$65 list**, please specify.



Optional casters - **add \$75 list**, please specify.

Model	Dimensions	Zone	COM	A	B	C	D	COL	L1	L2	L3	
SAT-3W Orbit	Width	17" x 17"	Will Call	590	655	695	745	850	655	715	770	850
	Height	23"	Zone 1	675	740	780	830	935	740	800	855	935
	COM	¾ yd.	Zone 2	685	750	790	840	945	750	810	865	945
	COL	11 sq. ft.	Zone 3	690	755	795	845	950	755	815	870	950
	Weight	23 lbs.	Zone 4	700	765	805	855	960	765	825	880	960



3-Way Swing Arm Table

Product Notes:

Swing Arm Tables can be attached under left, right, or middle Orbit seating units. Brackets for attachment are included. Available in all Taylor finishes.



For tables shipping via UPS, please add the following surcharges to the list price per table: **+\$75 list (Zone 1 & 2); +\$125 list (Zone 3 & 4)**.

To specify, include:

- Model Number
- Wood Finish
- Fabric | Leather
- Quantity

Wood Finishes

- RCL Royal Cherry
- LWL Light Walnut
- ESP Espresso
- MHL Mahogany
- SMK Smoke
- CML Clear Maple
- COL Clear Oak
- CHY Cherry
- AMB Amber
- BLK Black

Graded-In Fabric | Leather

Specific grades for fabrics and leathers can be found on the separate grade cards found in your Taylor binder. For fabric and leather patterns not graded-in, please contact Customer Service for pricing.

Dimensions

Dimensions listed in this price book are in inches and approximate.

Freight

Zone list pricing includes freight prepaid by Taylor for delivery to one destination only within the zone. See pg. 5 for details.

Large Order Freight Discount

For orders with 20 units or more, please contact Customer Service for pricing.

Minimum Prepaid Freight Charges

Orders with **5 or less chairs** (in any combination of guest, swivel, lounge, etc.) will be charged **\$195 list per order**.

5 | 15

Five Rooms in Fifteen Days

Seating marked with this logo is a part of Taylor's "Five Rooms in Fifteen Days" program. Refer to page 11 for details.

Model	Dimensions	Zone	COM	A	B	C	D	COL	L1	L2	L3	
SAT-120D Orbit	Width	17" x 17"	Will Call	565	630	670	715	805	630	690	745	805
	Height	23"	Zone 1	650	715	755	800	890	715	775	830	890
	COM	½ yd.	Zone 2	660	725	765	810	900	725	785	840	900
	COL	7 sq. ft.	Zone 3	665	730	770	815	905	730	790	845	905
	Weight	23 lbs.	Zone 4	675	740	780	825	915	740	800	855	915



Product Notes:

Swing Arm Tables can be attached under left, right, or middle Orbit seating units. Brackets for attachment are included. Available in all Taylor finishes.

For tables shipping via UPS, please add the following surcharges to the list price per table: **+\$75 list (Zone 1 & 2); +\$125 list (Zone 3 & 4).**

120 Degree Swing Arm Table

Model	Dimensions	Zone	COM	A	B	C	D	COL	L1	L2	L3	
SAT-INL Orbit	Width	13" x 18"	Will Call	565	630	670	715	805	630	690	745	805
	Height	23"	Zone 1	650	715	755	800	890	715	775	830	890
	COM	½ yd.	Zone 2	660	725	765	810	900	725	785	840	900
	COL	7 sq. ft.	Zone 3	665	730	770	815	905	730	790	845	905
	Weight	22 lbs.	Zone 4	675	740	780	825	915	740	800	855	915



Product Notes:

Swing Arm Tables can be attached under left, right, or middle Orbit seating units. Brackets for attachment are included. Available in all Taylor finishes.

For tables shipping via UPS, please add the following surcharges to the list price per table: **+\$75 list (Zone 1 & 2); +\$125 list (Zone 3 & 4).**

In Line Swing Arm Table

Model	Dimensions	Zone	COM	A	B	C	D	COL	L1	L2	L3	
SAT-EN Orbit	Width	13" x 18"	Will Call	535	595	640	685	765	595	660	710	765
	Height	23"	Zone 1	620	680	725	770	850	680	745	795	850
	COM	½ yd.	Zone 2	630	690	735	780	860	690	755	805	860
	COL	7 sq. ft.	Zone 3	635	695	740	785	865	695	760	810	865
	Weight	22 lbs.	Zone 4	645	705	750	795	875	705	770	820	875



Product Notes:

Swing Arm Tables can be attached under left, right, or middle Orbit seating units. Brackets for attachment are included. Available in all Taylor finishes.

For tables shipping via UPS, please add the following surcharges to the list price per table: **+\$75 list (Zone 1 & 2); +\$125 list (Zone 3 & 4).**

End Swing Arm Table

LOUNGE & MULTIPLE

Model	Dimensions		Zone	List Price
-------	------------	--	------	------------

**ST15R
Orbit**

Width 14" Dia.
Depth 22½"
Weight 22 lbs.

Will Call	440
Zone 1	455
Zone 2	465
Zone 3	480
Zone 4	490



Product Notes:

Swing Tables can be attached under left, right, or middle Orbit seating units.
Brackets for attachment are included.
Available in all Taylor finishes.

For tables shipping via UPS, please add the following surcharges to the list price per table:
+\$75 list (Zone 1 & 2); +\$125 list (Zone 3 & 4).



Round Swing Table

**ST15T
Orbit**

Width 16" x 17"
Depth 22½"
Weight 23 lbs.

Will Call	440
Zone 1	455
Zone 2	465
Zone 3	480
Zone 4	490



Product Notes:

Swing Tables can be attached under left, right, or middle Orbit seating units.
Brackets for attachment are included.
Available in all Taylor finishes.

For tables shipping via UPS, please add the following surcharges to the list price per table:
+\$75 list (Zone 1 & 2); +\$125 list (Zone 3 & 4).



Triangle Swing Table

**T30R
Orbit**

Width 30½" Dia.
Depth 15"
Weight 50 lbs.

Will Call	725
Zone 1	755
Zone 2	770
Zone 3	790
Zone 4	805

Product Notes:

Available in all Taylor finishes.

For tables shipping via UPS, please add the following surcharges to the list price per table:
+\$75 list (Zone 1 & 2); +\$125 list (Zone 3 & 4).

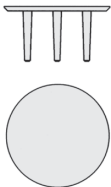

Round Occasional Table

**T30T
Orbit**

Width 30" x 27½"
Depth 15"
Weight 50 lbs.

Will Call	725
Zone 1	755
Zone 2	770
Zone 3	790
Zone 4	805

Product Notes:

Available in all Taylor finishes.

For tables shipping via UPS, please add the following surcharges to the list price per table:
+\$75 list (Zone 1 & 2); +\$125 list (Zone 3 & 4).

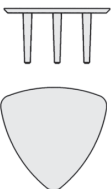

Triangle Occasional Table

LOUNGE & MULTIPLE

To specify, include:

- Model Number
- Wood Finish
- Edge Detail
- Quantity

Wood Finishes

- RCL Royal Cherry
- LWL Light Walnut
- ESP Espresso
- MHL Mahogany
- SMK Smoke
- CML Clear Maple
- COL Clear Oak
- CHY Cherry
- AMB Amber
- BLK Black

Dimensions

Dimensions listed in this price book are in inches and approximate.

Freight

Zone list pricing includes freight prepaid by Taylor for delivery to one destination only within the zone. See pg. 5 for details.

Large Order Freight Discount

For orders with 20 units or more, please contact Customer Service for pricing.

Minimum Prepaid Freight Charges

For tables shipping via UPS, please add the following surcharges to the list price per table:

Zone 1 & 2:	+\$75 list per table
Zone 3 & 4:	+\$125 list per table

5|15

Five Rooms in Fifteen Days

Seating marked with this logo is a part of Taylor's "Five Rooms in Fifteen Days" program. Refer to page 11 for details.

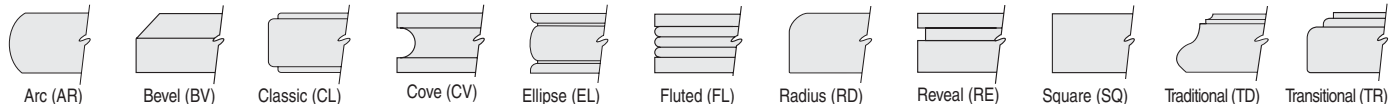

Model	Dimensions	Zone	List Price
-------	------------	------	------------

BC2030
Bedford Collection

5|15

Width 20" x 30"
Height 22"
Weight 40 lbs.

Will Call	525
Zone 1	550
Zone 2	560
Zone 3	575
Zone 4	585

Product Notes:

Crafted from maple veneer. Specify edge detail, see line drawings above. Shipped K.D. For shorter table heights - add \$25 net, please specify. Available in all Taylor finishes.

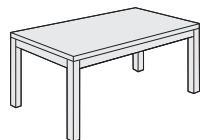

End Table

BC2424
Bedford Collection

5|15

Width 24" x 24"
Height 22"
Weight 40 lbs.

Will Call	525
Zone 1	550
Zone 2	560
Zone 3	575
Zone 4	585

Product Notes:

Crafted from maple veneer. Specify edge detail, see line drawings above. Shipped K.D. For shorter table heights - add \$25 net, please specify. Available in all Taylor finishes.

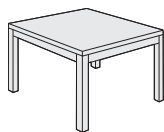

Corner Table

BC3030
Bedford Collection

5|15

Width 30" x 30"
Height 22"
Weight 51 lbs.

Will Call	615
Zone 1	640
Zone 2	655
Zone 3	675
Zone 4	685

Product Notes:

Crafted from maple veneer. Specify edge detail, see line drawings above. Shipped K.D. Available in all Taylor finishes.

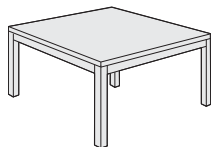

Corner Table

BC3030-16
Bedford Collection

5|15

Width 30" x 30"
Height 16"
Weight 51 lbs.

Will Call	590
Zone 1	615
Zone 2	630
Zone 3	650
Zone 4	660

Product Notes:

Crafted from maple veneer. Specify edge detail, see line drawings above. Shipped K.D. Available in all Taylor finishes.

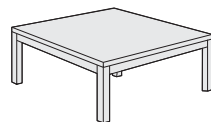

Coffee Table

BC2042
Bedford Collection

5|15

Width 20" x 42"
Height 16"
Weight 53 lbs.

Will Call	615
Zone 1	640
Zone 2	650
Zone 3	665
Zone 4	680

Product Notes:

Crafted from maple veneer. Specify edge detail, see line drawings above. Shipped K.D. For 22"H table height - add \$25 net, please specify. Available in all Taylor finishes.

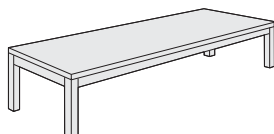

Coffee Table

To specify, include:

- Model Number
- Wood Finish
- Edge Detail
- Quantity

Wood Finishes

- RCL Royal Cherry
- LWL Light Walnut
- ESP Espresso
- MHL Mahogany
- SMK Smoke
- CML Clear Maple
- COL Clear Oak
- CHY Cherry
- AMB Amber
- BLK Black

Dimensions

Dimensions listed in this price book are in inches and approximate.

Freight

Zone list pricing includes freight prepaid by Taylor for delivery to one destination only within the zone. See pg. 5 for details.

Large Order Freight Discount

For orders with 20 units or more, please contact Customer Service for pricing.

Minimum Prepaid Freight Charges

For tables shipping via UPS, please add the following surcharges to the list price per table:

Zone 1 & 2:	+\$75 list per table
Zone 3 & 4:	+\$125 list per table

5|15

Five Rooms in Fifteen Days

Seating marked with this logo is a part of Taylor's "Five Rooms in Fifteen Days" program. Refer to page 11 for details.

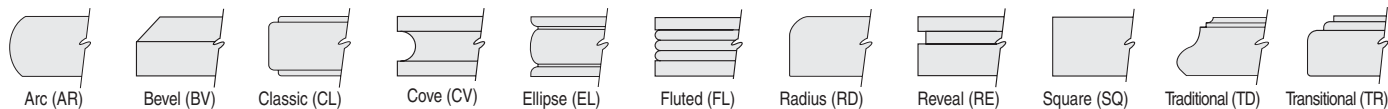

Model	Dimensions	Zone	List Price
-------	------------	------	------------

PG24RD
Paull Group

5|15

Width 20¼" Dia.
Height 22"
Weight 38 lbs.

Will Call	860
Zone 1	895
Zone 2	910
Zone 3	935
Zone 4	955

Product Notes:

Crafted from maple veneer. Specify edge detail, see line drawings above. Available in all Taylor finishes.



Drum Table

PG24R
Paull Group

5|15

Width 20¼" Dia.
Height 22"
Weight 32 lbs.

Will Call	750
Zone 1	780
Zone 2	790
Zone 3	810
Zone 4	825

Product Notes:

Crafted from maple veneer. Specify edge detail, see line drawings above. Shipped K.D. Available in all Taylor finishes.



Side Table

PG2030
Paull Group

5|15

Width 20" x 30"
Height 22"
Weight 34 lbs.

Will Call	550
Zone 1	575
Zone 2	585
Zone 3	600
Zone 4	610

Product Notes:

Crafted from maple veneer. Specify edge detail, see line drawings above. Shipped K.D. For shorter table heights - add \$25 net, please specify. Available in all Taylor finishes.

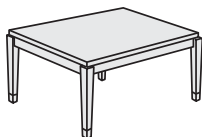

End Table

PG2424
Paull Group

5|15

Width 24" x 24"
Height 22"
Weight 32 lbs.

Will Call	550
Zone 1	575
Zone 2	585
Zone 3	600
Zone 4	610

Product Notes:

Crafted from maple veneer. Specify edge detail, see line drawings above. Shipped K.D. For shorter table heights - add \$25 net, please specify. Available in all Taylor finishes.

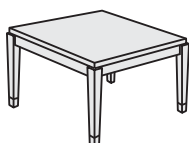

Corner Table

To specify, include:

- Model Number
- Wood Finish
- Edge Detail
- Quantity

Wood Finishes

- RCL Royal Cherry
- LWL Light Walnut
- ESP Espresso
- MHL Mahogany
- SMK Smoke
- CML Clear Maple
- COL Clear Oak
- CHY Cherry
- AMB Amber
- BLK Black

Dimensions

Dimensions listed in this price book are in inches and approximate.

Freight

Zone list pricing includes freight prepaid by Taylor for delivery to one destination only within the zone. See pg. 5 for details.

Large Order Freight Discount

For orders with 20 units or more, please contact Customer Service for pricing.

Minimum Prepaid Freight Charges

For tables shipping via UPS, please add the following surcharges to the list price per table:

Zone 1 & 2:	+\$75 list per table
Zone 3 & 4:	+\$125 list per table

5|15

Five Rooms in Fifteen Days

Seating marked with this logo is a part of Taylor's "Five Rooms in Fifteen Days" program. Refer to page 11 for details.

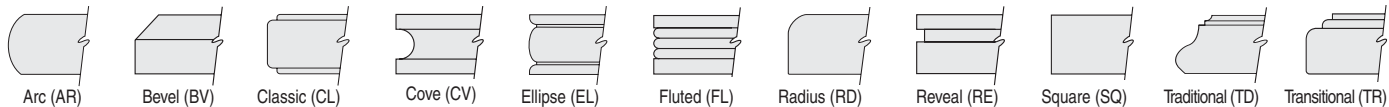

Model	Dimensions	Zone	List Price
-------	------------	------	------------

PG3030
Paull Group



Width	30" x 30"
Height	22"
Weight	38 lbs.

Will Call	640
Zone 1	665
Zone 2	680
Zone 3	700
Zone 4	710

Product Notes:

Crafted from maple veneer.
Specify edge detail, see line drawings above.
Shipped K.D.
Available in all Taylor finishes.

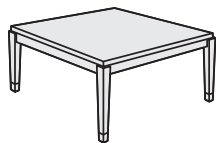

Corner Table

PG3030-16
Paull Group



Width	30" x 30"
Height	16"
Weight	38 lbs.

Will Call	615
Zone 1	640
Zone 2	650
Zone 3	670
Zone 4	680

Product Notes:

Crafted from maple veneer.
Specify edge detail, see line drawings above.
Shipped K.D.
Available in all Taylor finishes.

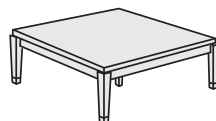

Coffee Table

PG2042
Paull Group



Width	20" x 42"
Height	16"
Weight	41 lbs.

Will Call	640
Zone 1	665
Zone 2	680
Zone 3	700
Zone 4	710

Product Notes:

Crafted from maple veneer.
Specify edge detail, see line drawings above.
Shipped K.D.
For 22"H table height - add \$25 net, please specify.
Available in all Taylor finishes.

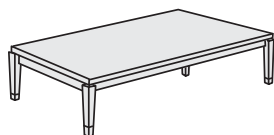

Coffee Table

UPHOLSTERY REQUIREMENTS & WEIGHTS

Model Number	All Leather in Square Feet	All Plain 54" Fabric or Vinyl in Yards	Approximate Shipping Weight (lbs.)	Model Number	All Leather in Square Feet	All Plain 54" Fabric or Vinyl in Yards	Approximate Shipping Weight (lbs.)
2110.5	34	2¾	64	2806T-4	34	2½	38
2111	31	2¼	39	2806UA	34	2½	38
2111-2S	62	4½	68	2806TUA	34	2½	38
2111-3S	93	6¾	91	2806UA-4	34	2½	38
2112	31	2¼	39	2806TUA-4	34	2½	38
2112-2S	62	4½	68	2806CA	48	3½	39
2112-3S	93	6¾	91	2806TCA	48	3½	39
2113	39	2¾	42	2806CA-4	48	3½	39
2115.5	34	2¾	61	2806TCA-4	48	3½	39
2120.5	41	3	67	2806.5UA	34	2½	60
2125.5	41	3	64	2806.5TUA	34	2½	60
2227-L	62	4½	93	2806.5CA	48	3½	61
2227-M	54	4	72	2806.5TCA	48	3½	61
2227-R	62	4½	93	2807.5	34	2½	66
2230-L	62	4½	95	2808	34	2½	37
2230-M	54	4	75	2808T	34	2½	37
2230-R	62	4½	95	2808CA	48	3½	38
2329	55	4	57	2808TCA	48	3½	38
2359	99	7¼	96	2808.5	34	2½	60
2429	81	6	53	2808.5T	34	2½	60
2459	115	8½	94	2808.5CA	48	3½	61
2510.5	44	3½	66	2808.5TCA	48	3½	61
2510.5BA	41	3½	63	2811.5	68	5	81
2510.5CA	51	3¾	68	2811.5T	68	5	81
2511.5	41	3½	56	2811.5TLC	68	5	81
2520	30	2¼	28	2812.5	71	5¼	84
2520.5	47	3¾	69	2812.5T	71	5¼	84
2520.5BA	44	3¾	66	2812.5TLC	71	5¼	84
2520.5CA	54	4	71	2813.5	78	5¾	86
2521.5	44	3¾	59	2813.5T	78	5¾	86
2530	91	6¾	80	2813.5TLC	78	5¾	86
2530C	91	6¾	80	2814	40	2¾	35
2530W	91	6¾	80	2814T	40	2¾	35
2530T	91	6¾	80	2814-4	40	2¾	37
2531	72	5¼	76	2814T-4	40	2¾	37
2532	58	4¼	60	2814.5	40	2¾	61
2532W	58	4¼	60	2814.5T	40	2¾	61
2550	58	4¼	46	2816	40	2¾	37
2554	129	9½	118	2816T	40	2¾	37
2554C	129	9½	118	2816.5	40	2¾	61
2554W	129	9½	118	2816.5T	40	2¾	61
2554T	129	9½	118	2818	38	2¾	36
2555	112	8¼	114	2819	24	1¾	28
2556	94	7	105	2831	105	7¾	70
2556W	94	7	105	2831T	112	8¼	70
2574	167	12	143	2860	150	11	91
2574C	167	12	143	2860T	156	11½	91
2574W	167	12	143	2880	189	14	130
2574T	169	12½	143	2880T	196	14½	130
2575	155	11½	139	4800.5	68	5	93
2576	128	9½	126	7414	24	1¾	35
2576W	128	9½	126	7415	27	2	35
2804-WLT	31	2¼	31	7415PA	30	2¼	39
2806	34	2½	38	7416	24	1¾	35
2806T	34	2½	38	7417	27	2	35
2806-4	34	2½	38	7417PA	30	2¼	39

UPHOLSTERY REQUIREMENTS & WEIGHTS

Model Number	All Leather in Square Feet	All Plain 54" Fabric or Vinyl in Yards	Approximate Shipping Weight (lbs.)	Model Number	All Leather in Square Feet	All Plain 54" Fabric or Vinyl in Yards	Approximate Shipping Weight (lbs.)
7612	41	3	35	9720.5CL-BA	68	5	63
7612.5	41	3	60	9720.5PF	58	4¼	66
7613	27	2	32	9720.5PF-BA	58	4¼	63
7614	41	3	35	9720.5SC	58	4¼	66
8114	38	2¾	36	9720.5SC-BA	58	4¼	63
8114.5	38	2¾	65	9810.5RA	52	3½	63
8810.5BA	34	2½	54	9810.5UA	52	3½	63
8810.5UA	38	2¾	54	9810.5CA	62	4¼	68
8810.5CA	45	3	58	9815.5RA	38	2¾	66
8811.5BA	38	2¾	56	9815.5UA	38	2¾	66
8811.5UA	41	3	56	9815.5CA	48	3½	68
8811.5CA	47	3¼	60	9820.5RA	62	4¼	69
9015	27	2	38	9820.5UA	62	4¼	69
9015-N	27	2	38	9820.5CA	70	5	71
9316	24	1¾	34	9825.5RA	41	3	68
9317	14	1	34	9825.5UA	41	3	68
9318	14	1	34	9825.5CA	51	3¾	70
9336	105	7¾	79	9830.5RA	68	4¾	72
9336FP	112	8¼	79	9830.5UA	68	4¾	72
9337	105	7¾	79	9830.5CA	77	5¼	74
9337FP	112	8¼	79	9835.5RA	48	3½	70
9360	145	10¾	109	9835.5UA	48	3½	70
9360FP	160	11¾	109	9835.5CA	58	4¼	72
9361	145	10¾	109	9911	27	2	34
9361FP	160	11¾	109	9912	31	2¼	34
9384	180	13¼	129	9912PA	44	3¼	37
9384FP	200	14¾	129	9913	34	2½	35
9385	180	13¼	129	9913PA	47	3½	38
9385FP	200	14¾	129	9920COS	27	2	27
9411	24	1¾	28	9930COS	54	4	54
9412	20	1½	27	9954COS	102	7½	86
9414	24	1¾	29	9974COS	149	11	115
9415	24	1¾	29	9920MAX	27	2	27
9416	12	1	28	9930MAX	102	7½	73
9417	20	1½	29	9931MAX	108	8	75
9500.5	65	4¾	57	9954MAX	130	9½	112
9500.5BA	65	4¾	54	9974MAX	170	13	137
9500.5CA	75	5½	61	9920MET	27	2	27
9510.5	65	4¾	55	9930MET	95	7	66
9510.5BA	65	4¾	52	9954MET	120	9	105
9510.5CA	68	5	59	9974MET	175	12½	131
9520.5	77	5¾	64	9920SAV	27	2	27
9520.5BA	77	5¾	61	9930SAV	102	7½	86
9520.5CA	81	6	67	9954SAV	133	9¾	124
9710.5CL	54	4	63	9974SAV	177	13	149
9710.5CL-BA	54	4	60	9920SLB	27	2	27
9710.5PF	44	3¼	63	9930SLB	95	7	70
9710.5PF-BA	44	3¼	60	9954SLB	135	9	97
9710.5SC	44	3¼	63	9974SLB	160	11½	132
9710.5SC-BA	44	3¼	60	OTT-R	54	4	33
9711-XB	24	1¾	33	OTT-T	54	4	33
9712-XB	12	1	32	SAT-120D	7	½	23
9713-XB	20	1½	32	SAT-3W	11	¾	23
9714	20	1½	32	SAT-EN	7	½	22
9715	20	1½	33	SAT-INL	7	½	22
9720.5CL	68	5	66				

NOTES



The Taylor Companies
One Taylor Parkway
Bedford OH 44146
Toll Free: 1. 888. 75TAYLOR

T: 440. 232. 0700
F: 440. 439. 6720
E: info@thetaylorcompanies.com
W: thetaylorcompanies.com